



PerfectSheer[™] & SmartDrape[™] Shades

PROGRAM REFERENCE GUIDE



Date	Program	Revision
10/15/2025	PerfectSheer™	<p>Pg. 9, 11: Updated max. common valance quantity and rule.</p> <p>Pg. 10: Updated Valance Joinery and Splicing Rules.</p>
10/1/2025	SmartDrape™	<ul style="list-style-type: none"> Added ceiling mount and C clip installation. Updated information and drawings for ceiling mount.
9/24/2025	PerfectSheer™	<ul style="list-style-type: none"> Updated Motorized shade min. width.
9/24/2025	SmartDrape™	<ul style="list-style-type: none"> Updated Motorized shade min. width. Updated Hardware Quantity.
8/15/2025	SmartDrape™	<ul style="list-style-type: none"> Added motor, battery pack, master/sub gearbox and wand base in Matte Silver, Brass and Bronze.
8/1/2025	PerfectSheer™	<ul style="list-style-type: none"> Corrected color name. Added PerfectSheer Color Coordination file. Detailed color coordination can be referenced in the appendix.
8/1/2025	SmartDrape™	<ul style="list-style-type: none"> Expanded size limitation. Updated Additional Vanes information.
7/1/2025	SmartDrape™	<ul style="list-style-type: none"> Updated Stacking Width description. Running change: Nickel-plated nuts on SmartJoint Connectors will be color coordinated. Added SmartDrape Color Coordination file. Detailed color coordination can be referenced in the appendix.
7/1/2025	PerfectSheer™	<ul style="list-style-type: none"> Added connector for Curved fascia with fabric. Discontinued color Pure White in Premium Wood Light Guard.
5/31/2025	SmartDrape™	<ul style="list-style-type: none"> Added power source: (Norman Smart AC Adapter Plug in for Motorized SmartDrape. Added charging extension wand color for Motorized SmartDrape (Norman Smart Rechargeable Battery).
5/30/2025	PerfectSheer™	<ul style="list-style-type: none"> Added 16" Cord length.
4/9/2025	SmartDrape™	<ul style="list-style-type: none"> Updated min. Width for Motorized SmartDrape.
3/31/2025	SmartDrape™	<ul style="list-style-type: none"> Added color coordination for Motorized SmartDrape.
3/31/2025	PerfectSheer™	<ul style="list-style-type: none"> Updated max. Width for Motorized PerfectSheer. Added Valance Deduction. Updated non-spliced single valance length. Update rule for Keystone quantity. Updated Valance Joinery rule and keystone location. Updated Control Wand color to Color Coordination.
3/1/2025	SmartDrape™	<ul style="list-style-type: none"> Added 6 fabric colors, and Bronze and Brass head rail.
3/1/2025	PerfectSheer™	<ul style="list-style-type: none"> Updated Side by Side rule. Updated the Fabric Valance / Fascia Size Chart. Added custom cord drop for Common Valance Perfect Sheer Updated Valance Joinery rule.
12/19/2024	PerfectSheer™	<ul style="list-style-type: none"> Discontinued color Crisp Linen and Matte Black in Premium Wood Light Guard.
11/16/2024	SmartDrape™	<ul style="list-style-type: none"> Updated three Track width size for Side by side. Updated L bracket/Shim Qty for Center opening.



PerfectSheer™ Shades

	Page
General Specifications	<u>4</u>
Lift Systems & Terminology	<u>5 – 6</u>
Valance Options	<u>7 – 10</u>
Mounting Requirements & Fabric Deductions	<u>12 – 14</u>
Additional Options	<u>15 – 16</u>
Fabric List & Color Coordination	<u>17</u>
PerfectSheer Shades Expectations	<u>18 – 21</u>
Product Care	<u>22</u>

SmartDrape™ Shades

General Specifications	<u>23 – 24</u>
Terminology	<u>25</u>
Shade Configurations	<u>26 – 30</u>
Mount Types	<u>31 – 32</u>
Parts and Hardware	<u>34</u>
Additional Options	<u>35 – 38</u>
Fabric List & Color Coordination	<u>39 – 40</u>
Complete Color Coordination Chart	See Appendix
Fabric Disclaimers & Product Care	<u>41</u>

Size Considerations

	Continuous Cord Loop		Motorized	
	Width	Height	Width	Height
Min.	12"	12"	16"*	12"
Max.	98"	98"	109"	120"
Ratio limit**	The width to height ratio is 1:4 for all fabrics.			

*Min. Shade Width differs for each motor. Detail information listed in Motorization Program Guide.

**The height of a continuous cord loop or motorized shade cannot exceed more than 4 times its width.

Side by Side

Side by Side is a great solution for covering wide openings. Side by Side will match tube size and shade bracket size by upgrading to the larger size within the shades selected. This is ideal when a uniform look for shades of different shade widths within a room is requested. Vane Alignment* will be provided when ordered at the same time and the following attributes are the same:

- Room
- Mount type
- Shade height
- Color
- Lift system
 - motor type/power source (if applicable)
- Valance type and size
- Valance return length

* Vane Alignment

When Side by Side is selected in order entry and the shades are ordered with same attributes mentioned, the banded layer alignment will be within a ¼" tolerance.

Size Definition / Standard Deductions

Shade Width

- Shade with Valance: The shade width is measured from the left edge of the bracket to right edge of bracket
- Shade with Fascia: The shade width is measured from left edge of end cap to right edge of end cap

Shade Height

- The shade height is measured from the top of the raceway to the bottom of the hem bar when the shade is completely lowered

Inside Mount: shade width = order width – 1/8"

Outside Mount: shade width = order width

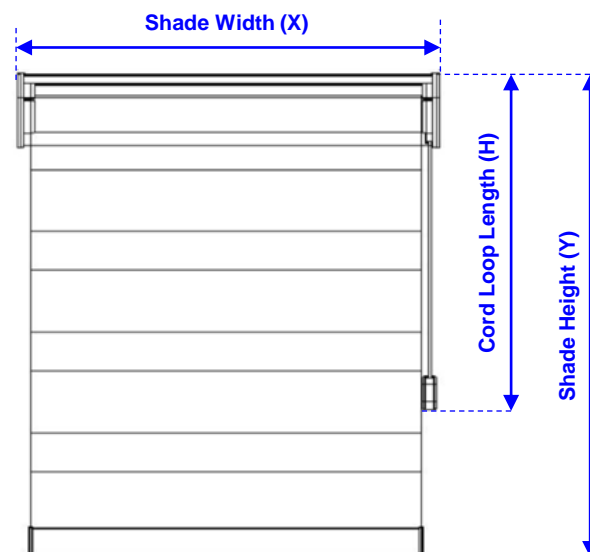

Continuous Cord Loop

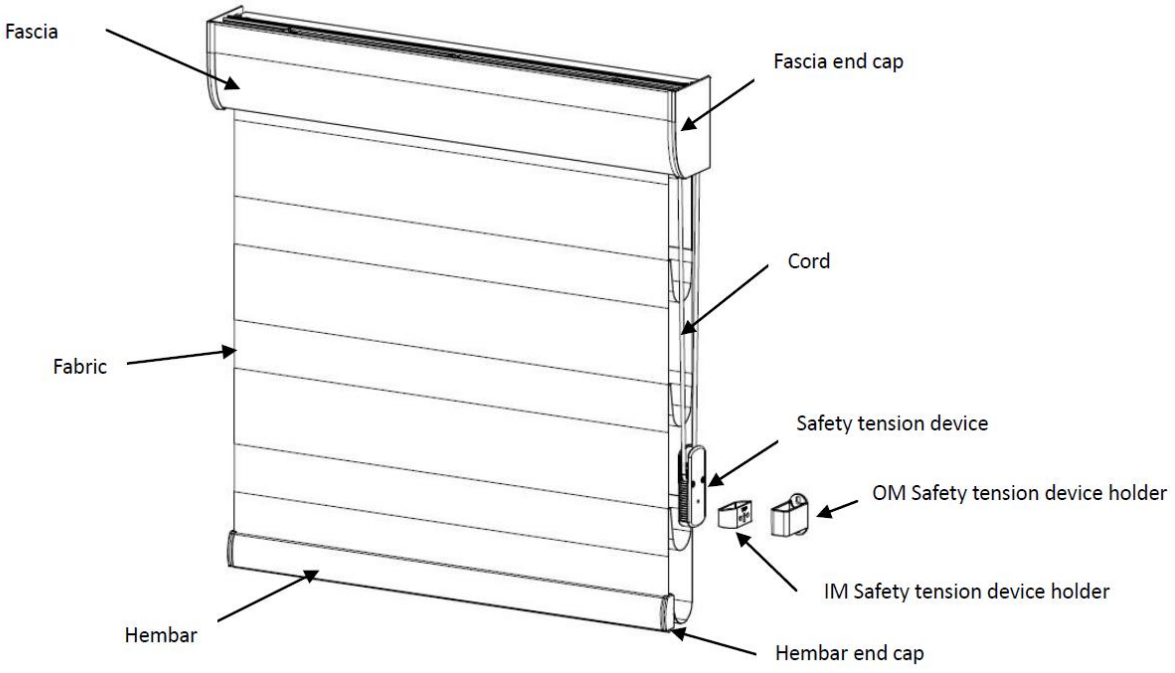

Motorized

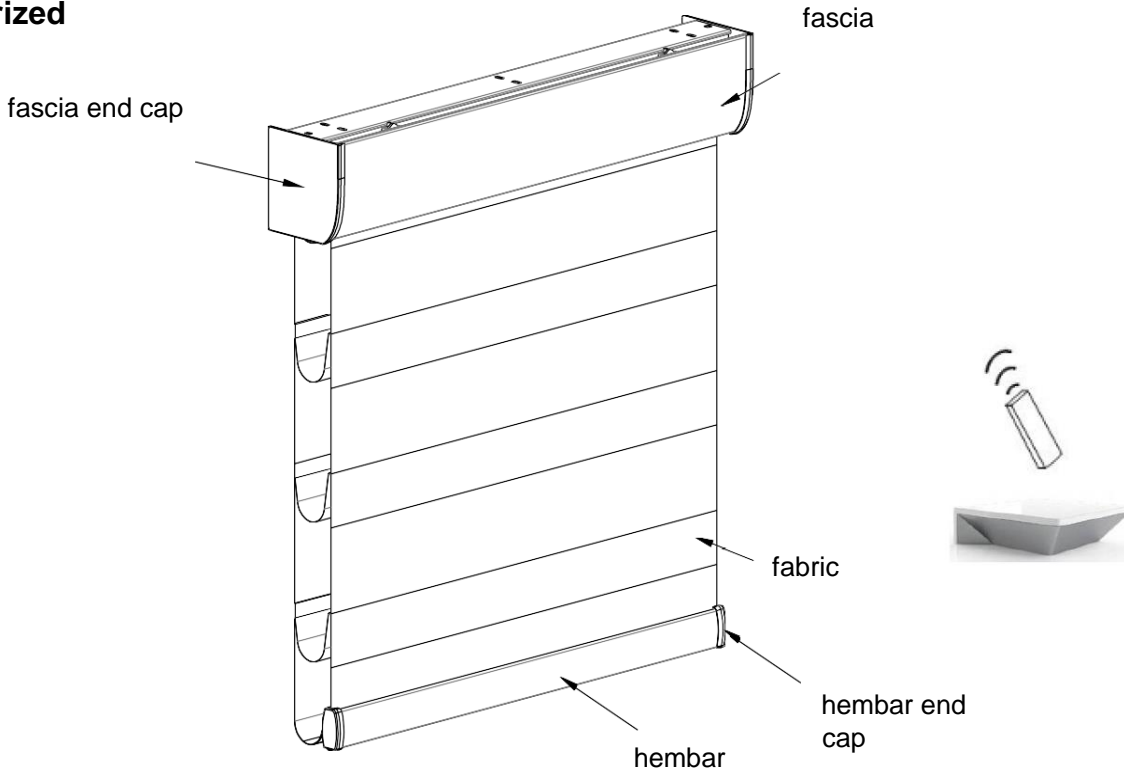

Continuous Cord Loop - Control

Cord Length

Cord Loop Length (Y2)	
Shade Height (Y)	Default Cord Length
$Y \leq 20"$	9"
$20" < Y \leq 30"$	16"
$30" < Y \leq 42"$	24"
$42" < Y \leq 55"$	36"
$55" < Y \leq 69"$	48"
$69" < Y \leq 95"$	60"
$Y > 95"$	84"
Shade Height (Y)	Custom Cord Length
All Shade Heights	Min length: 9" *The max custom cord loop length should be no more than $(\text{order length} - 2")/1.1$

Control Locations

Default	Optional
Right	Left

Valance deduction

Inside Mount		
Valance		Finished Width
Fascia Width	including end caps	Fascia width = shade width* Common fascia width** = left/center/right total shade order width+ gaps between shades – 1/8"
	excluding end caps	Fascia width = shade width* – 1/8" Common fascia width** = left/center/right total shade order width+ gaps between shades – 1/4"
Wood/ Fabric Valance Width	excluding valance returns	Valance width = shade width*
		Common valance width**= left/center/right total shade order width+ gaps between shades –1/8"

*Shade width = order width – 1/8"

**For common fascia/ valance: 1/8" width deductions will be taken from each shade width measurement entered.



Semi-Inside Mount		
Valance		Finished Width
Fascia Width	including end caps	Fascia width = shade width* Common fascia width** = left/center/right total shade order width+ gaps between shades – 1/8"
	excluding end caps	Fascia width = shade width* – 1/8" Common fascia width** = left/center/right total shade order width+ gaps between shades – 1/4"
Wood/Fabric Valance Width	including valance returns	Valance inner width = shade width* + 3/16" x return qty
		Common valance inner width**= left/center/right total shade order width+ gaps between shades – 1/8" + 3/16" x return qty
		For Fabric Valance: Valance width = Valance inner width + 5/16" x return qty
		For Wood Modern Valance: Valance width = valance inner width + 7/16" x return qty

*Shade width = order width – 1/8"

**For common fascia/ valance: 1/8" width deductions will be taken from each shade width measurement entered.

Outside Mount		
Valance		Finished Width
Fascia Width	including end caps	Fascia width = shade width* Common fascia width = left/center/right total shade order width+ gaps between shades
	excluding end caps	Fascia width = shade width* – 1/8" Common fascia width = left/center/right total shade order width+ gaps between shades – 1/8"
Wood/ Fabric Valance Width	including valance returns	Valance inner width = shade width* + 3/16" x return qty
		Common valance inner width= left/center/right total shade order width+ gaps between shades + 3/16" x return qty
		For Fabric Valance: Valance width = (common) valance inner width + 5/16" x return qty
		For Wood Modern Valance: Valance width = (common) valance inner width + 7/16" x return qty
Wood/ Fabric Valance Width	excluding valance returns	Valance width = shade width* = order width
		Common valance width= left/center/right total shade order width+ gaps between shades

* Shade width = order width

Valance Options	Color	Note	Valance Size
 Curved Fascia with Fabric	Defaulted to selected shade fabric. Optional fabric selection is available.	The max single fascia width is 93". When exceeded, the single fascia will be spliced with keystone or connector as supplied.	3 ½" or 4 ½" * Refer to Fabric Valance / Fascia Size chart.
 Fabric Valance	Defaulted to selected shade fabric. Optional fabric selection is available.	The max single valance width is 93". When exceeded, the valance will be spliced with keystone or connector as supplied. Valance returns available for semi IB & OB	3 ½" or 4 ½" * Refer to Fabric Valance / Fascia Size chart
 Modern Valance	Paint: 001 Pure White 003 Silk White 006 Pearl 012 Crisp Linen 049 Stone Gray 053 Clay Stain: 109 Weathered Teak 110 Limed White 212 Dark Teak 221 Black Walnut 237 Wenge 246 Matte Black See digital swatches here.	The max single valance width is 93". When exceeded, the valance will be spliced with keystone or connector as supplied. Valance returns available for semi IB & OB Material: Wood	4 ½"

**Valances are not recommended for door applications.

Fabric Valance / Fascia Size Chart			
Shade Width (X)	Shade Height (Y)	Fabric Valance / Fascia Size	Valance Bracket Size
All widths	$Y \leq 72"$	Default: 3 ½" Option: 4 ½"	Default: Small Bracket Option: Large Bracket
	$> 72"$	4 ½"	Large Bracket

Notes: The rule applies to single shade or an individual shade with common valance or side by side. To receive the available valance size, each shade per unit must order within the height limits.

Valance Options

Customized Valance Width

- The max custom valance width can be up to 12" wider than the shade width.

Common Valance

- Common valance is available in all Valances
- One common valance can be shared up to 6 independently operated shades.
 - (Exception: Continuous Cord Loop/ AutoWand system only provide 2 shades under common valance.)*
 - All shades sharing a common valance must use the same lift system.
 - same motor type/power source (if applicable)
- The gap between each shade is 0" by default; maximum gap is up to 12"
- Common valance will match tube size and shade bracket size by upgrading to the larger size within the shades selected.
- For continuous cord loop system

Default cord loop length: cord length will be supplied according to the shade height of each shade.

Custom cord loop length: cord length will be supplied as per custom cord length for each shade.

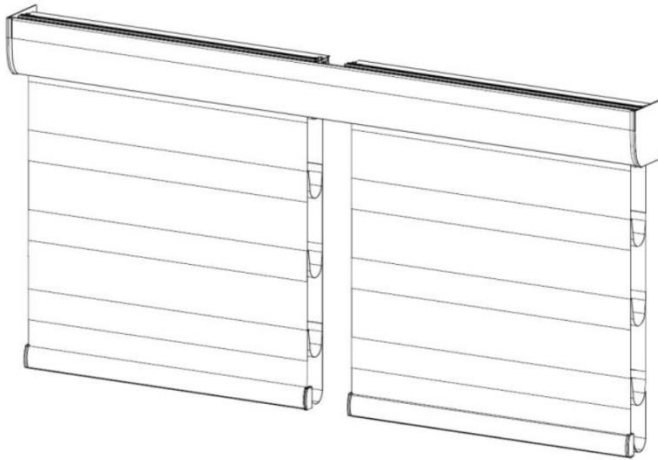

Control Location	
CordLoop/ AutoWand	Left Shade: L Right Shade: R

Valance Return Size Options

Valance Type	Definition	Semi-Inside Mount	Outside Mount	Tolerance
Fabric	From the back of the valance to the end of the return.*	Default: 1" Custom sizes: 1 1/8" ~ 4 1/2"	Default: Standard based on shade configurations	+/- 1/8"
Modern	Inner length.	Default: 1" Custom sizes: 1/2" - 4 1/2"	Custom sizes <u>longer</u> than the standard: 1/8" ~ 1"	

*Thickness of wrapped fabric may cause fabric valance return slightly longer or shorter than order size.

Splicing Valances

Valances wider than its maximum limitations will be spliced. A **valance joinery** method is required to provide support on all spliced valances. This applies to single and common valance.

Valance Joinery and Splicing Rules

Type	Valance	Max Valance Width Without Joint	Max Valance Width With Joint	Valance Joinery		Splice Location				
				Default	Optional	Default	Optional			
Single	Curved Fascia with Fabric	Fascia End Cap to End Cap: 93"	Shade Width (X) + 12"	Connector	Keystone (Up to 5)	Equally Centered	Custom split location (For Keystone only)			
	Fabric Valance (inner width)	93"								
	Modern Valance (inner width)									
Common	Curved Fascia with Fabric	Fascia End Cap to End Cap: 93"	Total Shade Widths + total gap width + 12" ≤ 558" (max. valance width 93"x 6pcs)				Connector	Keystone (Up to 5)	Equally Centered	*Custom split location (For Keystone only)
	Fabric Valance (inner width)	93"								
	Modern Valance (inner width)									

- For Continuous Cord Loop/ AutoWand system under common valance:
 - Total Shade Widths + Gap Sizes + 12" ≤ 186"
 - The max valance width with joint will be Total Shade Widths + Gap Sizes + 12" ≤ max valance width 93"x2pcs
 - Up to 3 keystones can be selected per valance

Keystone

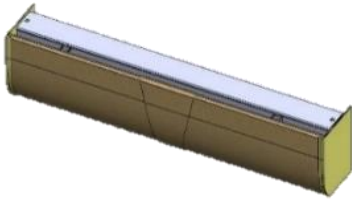

Curved Fascia with fabric Keystone

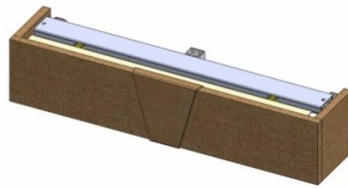

Fabric Valance Keystone



Modern Valance Keystone

Keystones for fascia with fabric/ fabric valance/ wood valances will also be provided with a set of fascia connector/ valance connectors for additional support.

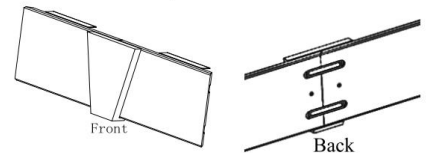

Connector

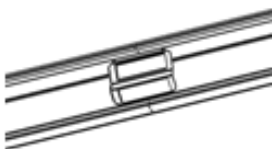

Curved Fascia Connector

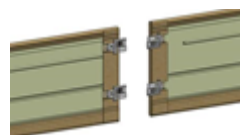

Fabric Valance connector



Wood Modern Valance connector

Keystone Spacing Requirements

Measure from the left of the valance inner width to the center of the keystone. Minimum distance between 2 keystones is 18" and the min. distance between either ends of the valance to the keystone center is 18".

Keystone Qty		Custom keystone location limitation	
		Min	Max
1 Keystone		18"	total valance width-18"
2 Keystones	1st keystone	18"	total valance width-18"x2
	2nd keystone	1st keystone location+18"	total valance width-18"
3 Keystones	1st keystone	18"	total valance width-18"x3
	2nd keystone	1st keystone location+18"	total valance width-18"x2
	3rd keystone	2nd keystone location +18"	total valance width-18"
4 Keystones	1st keystone	18"	total valance width-18"x4
	2nd keystone	1st keystone location+18"	total valance width-18"x3
	3rd keystone	2nd keystone location +18"	total valance width-18"x2
	4rd keystone	3rd keystone location +18"	total valance width-18"
5 Keystones	1st keystone	18"	total valance width-18"x5
	2nd keystone	1st keystone location+18"	total valance width-18"x4
	3rd keystone	2nd keystone location +18"	total valance width-18"x3
	4rd keystone	3rd keystone location +18"	total valance width-18"x2
	5rd keystone	4rd keystone location +18"	total valance width-18"

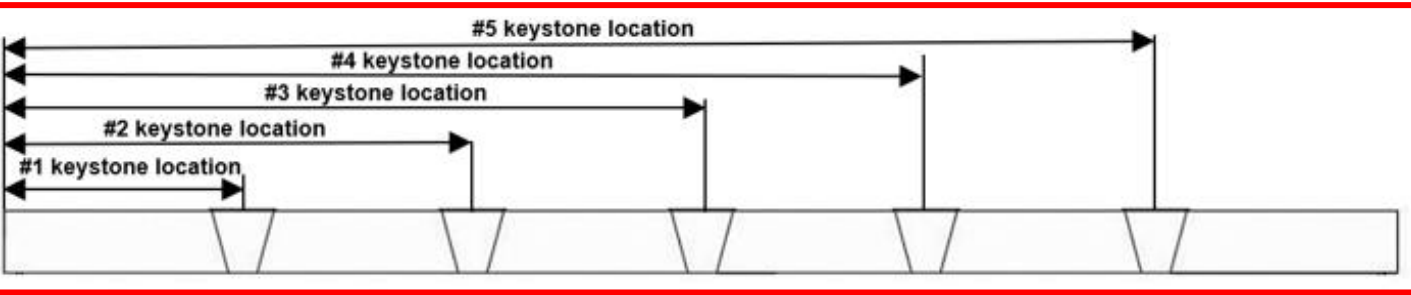

IM Mounting Depth - Continuous cord loop

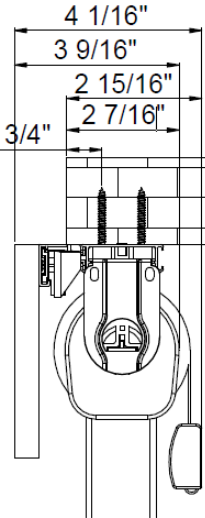
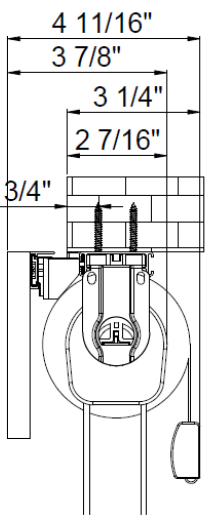
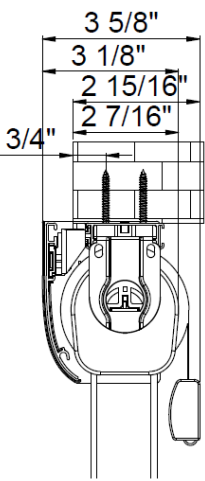
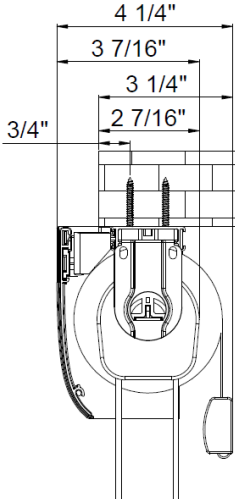
Item	Drawing (with max shade length and RD fabric)	
Cord Loop Shade with Valance	 <p data-bbox="455 956 776 989">Small Valance Bracket</p>	 <p data-bbox="886 956 1208 989">Large Valance Bracket</p>
Cord Loop Shade with Fascia	 <p data-bbox="455 1611 776 1644">Small Valance Bracket</p>	 <p data-bbox="858 1611 1179 1644">Large Valance Bracket</p>

IM Mounting Depth - Motorized

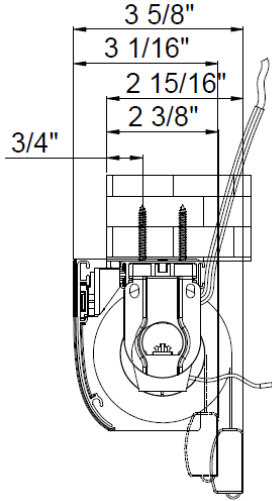
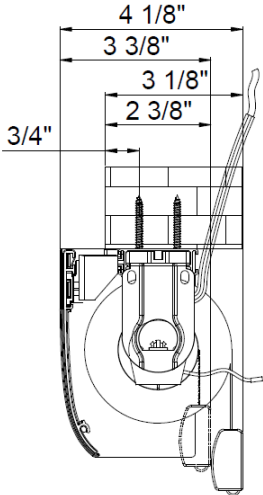
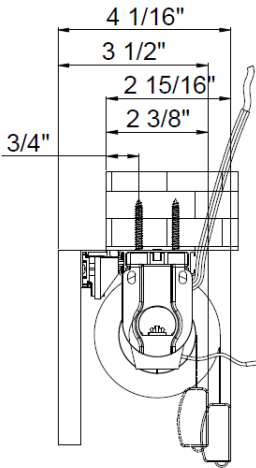
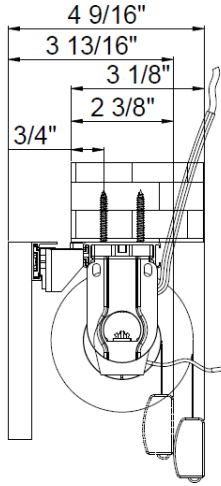
Item	Drawing (with max shade length and RD fabric)	
Motorized Shade with Valance	 <p style="text-align: center;">Small Valance Bracket</p>	 <p style="text-align: center;">Large Valance Bracket</p>
Motorized Shade with Fascia	 <p style="text-align: center;">Small Valance Bracket</p>	 <p style="text-align: center;">Large Valance Bracket</p>

When shade is inside mount, customer can also order outside mount bracket if needed for wall/back mount.

When shade is outside mount, customer can also choose inside mount(top mount) option and raceway will be pre-drilled holes for screwing.

Mount Type	Bracket Type	
	Inside(top mount)	Outside(wall/back mount)
Inside (Take Deductions)	With Raceway – Previous Raceway raceway will be pre-drilled holes for screwing	With Raceway – New Raceway with new OM Brackets
Outside (No Deductions)	With Raceway – Previous Raceway raceway will be pre-drilled holes for screwing	With Raceway – New Raceway with new OM Brackets

Inside Mount Fabric Width Deductions

Continuous Cord Loop – Single Inside Mount				
Shade Width	Shade Length	Tube Size	Valance	Finished Fabric Width
12" to 98"	12" to 98"	1 3/4"	CCL with Fascia	Fabric Width = Order Width - 1.64"
			CCL with Valance	Fabric Width = Order Width - 1.44"

Single Motorized - Inside Mount					
Motor Type	Shade Width	Shade Length	Tube Dimensions	Shade Type	Tube/Fabric Width
Norman Smart Rechargeable Battery with AC Adapter Charger	All widths	All heights	1 3/4" / 2"	Motorized with Fascia	Tube Width = Order Width - 1.44"
					Fabric Width = Order Width - 1.68"
				Motorized with Valance	Tube Width = Order Width - 1.25"
					Fabric Width = Order Width - 1.48"
All other motorization	All widths	All heights	1 3/4" / 2"	Motorized with Fascia	Tube Width = Order Width - 1.38"
					Fabric Width = Order Width - 1.62"
				Motorized with Valance	Tube Width = Order Width - 1.19"
					Fabric Width = Order Width - 1.42"

Additional Options

OM Mounting Depth

Mounting area required for Outside Mount

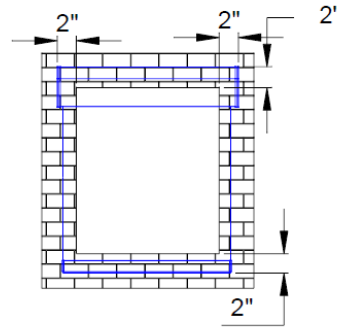
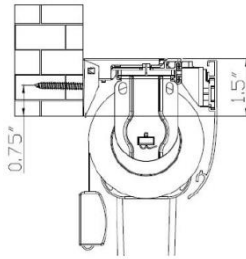

Light Guard

- Light Guard is specifically designed to block incoming light escaping off the top and sides of the window opening.
- Application consists of 2 side blocks (select from premium wood light guard or basic light guard), plus a top block piece

	Dimensions	Available colors				
Premium Wood Light Guard (Side Channels)		<p>*The wood light guard will be provided with only 1 size (approx.) 1 3/8".</p>				
Basic Light Guard (Side Channels)	<p>End Caps</p> <p>*End Caps will come pre-installed on top of the light guard pieces.</p>	<p>Light Guard Splicing Rule When the light guard length (L) is over 96", it will be spliced into two pieces. The splicing points are as follows:</p> <table border="1"> <thead> <tr> <th>96" < L ≤ 102"</th> <th>L > 102"</th> </tr> </thead> <tbody> <tr> <td>From the top down at 6"</td> <td>From the bottom up at 96"</td> </tr> </tbody> </table>	96" < L ≤ 102"	L > 102"	From the top down at 6"	From the bottom up at 96"
96" < L ≤ 102"	L > 102"					
From the top down at 6"	From the bottom up at 96"					
Top Light Block	4 1/2"	Standard color: White				

Shims

- Dimensions: 1 5/8" x 3/8"
- Approx.. 3/8" thick for one and 11/16" thick for two stacked
- Up to 3 shims/spacers can be stacked per bracket

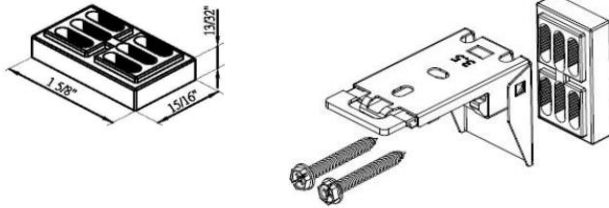

Shade width X	8" ≤ X ≤ 40"	40" < X ≤ 80"	X > 80"
# of mounting brackets	2	3	4
# of shims (1 layer)	2	3	4
# of shims (2 layers)	4	6	8
# of shims (3 layer)	6	9	12

Magnetic Hold-Down

- Two hold down brackets (one for the left and the right side of the shade) will be provided for each shade when requested.
- Defaulted for door applications.
 - Magnetic hold-downs are required for door applications to help keep the shade in place.
 - Not recommended for metal door applications.
- Optional for window applications.
- The magnet will be pre-installed at the factory on the hem bar.
- The magnet catch, which needs to be installed at the job site, can be found in the hardware box.

Allow extra wall space for installation:

- 9/16" in length from the side edge of the shade
- 11/16" in height from the bottom edge of the shade

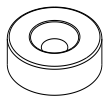
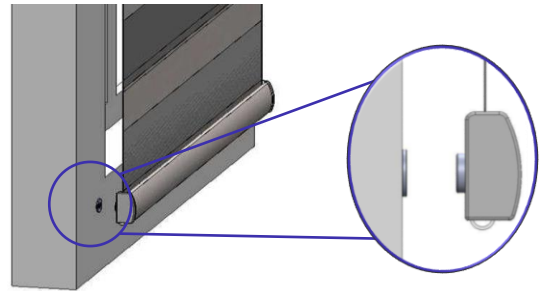

Magnet

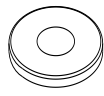

Magnet Catch

Available colors for Magnet Catch

- Nickel-Plated (Default)
- (Optional) Pure White, Silk White, Bisque, Pearl, Bright Brass, Antique Brass, Black, Crisp Linen, String, Sea Mist, Stone Gray, Brown Gray, Taupe Gray

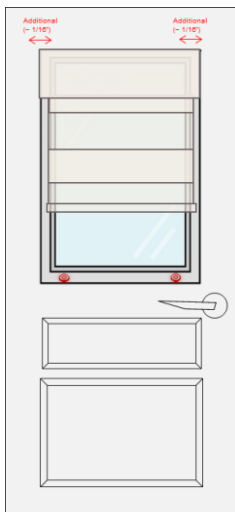
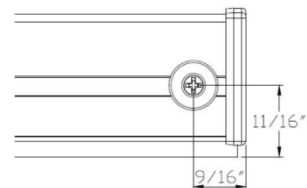

PerfectSheer Shades Installed on a Door

To receive shades suited for door applications, please select the option during order entry. When selected,

- Shades will have an additional fabric deduction of approximately 1/16" (2mm) on each side in order to prevent the fabric from fraying. (See fabric deductions by lift system for total fabric width deductions.)
- Magnetic hold-downs are defaulted and required when installed on a door.
- Valances are available but not recommended for door applications.

See Color Coordination Chart for detailed color information.

	Fabric List			Color Coordination		
	Opacity	Color Code	Color Name	Cord Color	Raceway, Brackets, Hem bar	Fascia/ Hem bar end caps, Safety tension device, Clutch
1	Light Filtering	F1191	Nightfall	Dark Gray	Black	Black
2		F1192	Granite	Dark Gray	Black	Black
3		F1193	Mineral	Silver	Cottage White	Chocolate
4		F1178	Snowflake	White	White	White
5		F1179	Lily Cream	Alabaster	Cottage White	Cottage White
6		F1180	Dunes	Petal Pink	Cottage White	Terra
7		F1181	Smoke	Smoke	White	Silver
8		F1182	Midnight	Black	Black	Black
9		F1183	Cottonwood	Petal Pink	Cottage White	Nature
10		F1184	Cedar Cream	Alabaster	Cottage White	Sahara
11		F1185	Quarry	Silver	White	Silver
12		F1186	Soft White	White	White	White
13		F1187	Cinnamon	Petal Pink	White	Terra
14		F1188	Platinum	Silver	Cottage White	Cottage White
15		F1189	Magnetic Gray	Smoke	White	Silver
16		F1190	Cast Iron	Dark Gray	Black	Black
17		F1194	Frosty Asphalt	Dark Gray	Black	Black
18		F1195	Frosty Gray	Silver	White	Silver
19		F1196	Frosty White	White	White	White
20		F1197	Light Gray	Smoke	White	Silver
21		F1363	Ivory	Alabaster	Cottage White	Cottage White
22		F1364	Silver	White	White	White
23	Room Darkening	F1200	Moon	White	White	White
24		F1201	Silk	Alabaster	Cottage White	Cottage White
25		F1202	Chai Latte	Petal Pink	Cottage White	Terra
26		F1203	Sky	Smoke	White	Silver
27		F1204	Mars Black	Black	Black	Black
28		F1205	Seaside	Petal Pink	Cottage White	Nature
29		F1206	Palm	Alabaster	Cottage White	Sahara
30		F1207	Stone	Silver	White	Silver
31		F1208	Heather Gray	Smoke	White	Silver
32		F1209	Ash Gray	Dark Gray	Black	Black

Fabric Composition: 100% Polyester

Sheer Shades have been an elegant window treatment solution for decades. Our introduction of PerfectSheer™ comes after years of engineering and design. PerfectSheer™ truly delivers on a number of desired effects of fine window treatments:

- Light transformation
- UV protection
- Softened views while enjoying privacy



We have delivered on these needs while incorporating superior industry enhancements:

- Tightest vane closure in its category for privacy/light control
- 100% Woven seams; not glued, sewn or heat fused
- Hem bar doesn't rise above the window sill in the closed position

But as with all fine window treatments there are certain inherent characteristics of a PerfectSheer™ Shade that can be found in any sheer shade in the market. Since we always strive to provide the highest quality window treatment solutions, we are communicating certain industry-wide operation or fabric characteristics of sheer shades.

Room Darkening versus Blackout Quality

One of the appealing characteristics of a sheer shade is its ability to softly filter light when open and provide varying levels of privacy when closed. While our room darkening fabrics provide more privacy and light control qualities than our light filtering choices, they are not a total blackout solution.

This results from several operating aspects associated with any sheer shade:

Multi Plane Operation

Because of the need to operate on several opposing planes – height, width, depth and in between angles, PerfectSheer™'s vanes are not designed to close completely, most notably at the bottom of the shade. However, vane overlap ensures that privacy is not compromised.



Front View

Side View

Hem Bar Rotation

An inherent characteristic of a sheer shade is that the bottom hem bar rises and lowers off the window sill as the vanes are rotated. Fortunately, unlike some other sheer shades, PerfectSheer™ is designed where the hem bar rests on the window sill when the vanes are closed and rises slightly in the open position, providing maximum light control and privacy.



Open Position



Closed Position

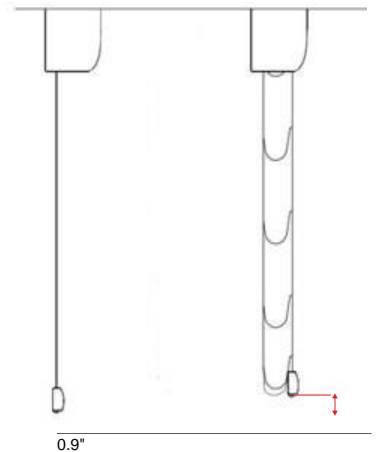

Fabric Characteristics

PerfectSheer™ offers an array of light filtering and room darkening fabrics. As is the nature of all textiles, there are certain characteristics associated with our fabric collection that are considered normal and not flaws.

Wrinkles, Creases and Reverse Light Effect

Slight wrinkles, creases and reverse light effects may appear which are considered normal

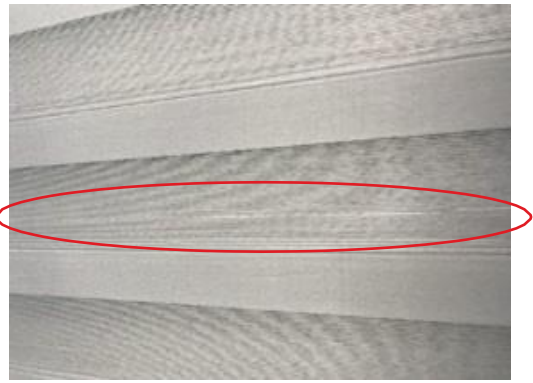

Woven Seam Construction

Because PerfectSheer™'s seams are finely woven not glued, sewn or heat fused, they have a more natural appearance and may not be perfectly straight



Edge Fraying

Small strands of sheer yarn may appear on the shade's vertical edges because of the nature of sheer fabrics. These are considered normal and may be clipped by the consumer. The weaving process may also result in edges that are not perfectly aligned.

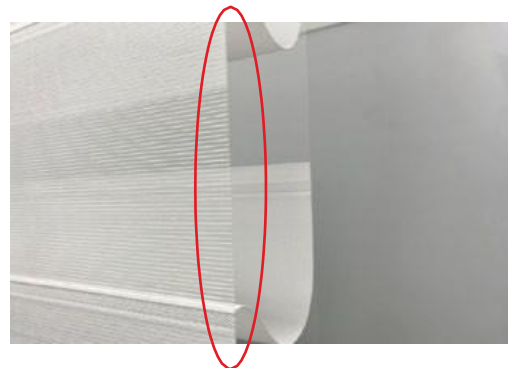

Vane Bowing

The top vane of the shade may bow slightly which is considered normal

**Order Accuracy****Vane Alignment**

When Side by Side is selected in order entry and the shades ordered at the same time, with the same color and height, the banded layer alignment will be within a 1/4" tolerance.

**This includes RGAs. As long as all other criteria is identical, the RGA shades will be subject to the same vane alignment rule with 1/4" tolerance.*

Shade Height

When confirming the accuracy of the ordered height measure with the vanes fully closed.

Our Heritage of Quality

With Norman®, Quality isn't just a catchphrase, it's our Heritage.

Our PerfectSheer™ shade will provide your consumer with years of trouble free operation and enjoyment. It is of course backed by our Lifetime Warranty should anything out of the ordinary occur

Maintaining PerfectSheer™ Shades

Routine cleaning will help maintain the beauty of your shade. Here are the proper methods for cleaning PerfectSheer shades:

Light Dusting

- Use a duster or gentle air blower to remove any dust. Do not vacuum.

Spot Cleaning

- Spot cleaning is not recommended as the fabric material is not water resistant.

Ironing

- One of the benefits of polyester is its non-wrinkling qualities. However, if wrinkles or creases develop, use a steam iron on a medium heat setting (356°F-392°F) to eliminate any unwanted wrinkles.



Program Overview

Application	Operation	Stack Options	Track Sizes
Single Shade	Wand Tilt	Left	Configurations 1
		Right	Configurations 1
		Traveling Center Stack	Configurations 1
	Motorized	Left	Configurations 1
		Right	Configurations 1
		Center Opening	Configurations 3
Side by Side Shades	Wand Tilt	Left Shade: L and Right Shade: R	Configurations 2
		Traveling Center Stack	Configurations 2

Size Limitations

The size limitations are a general reference. Order widths are not custom and must be selected from the available sizes. The Shade Width will be determined by the selected Track Width. Choose from the preferred operation type and stack option type to determine the Track Size Configurations available.

Operation & Stack Option	Min Width		Max Width		Min Height	Max Height	Max Area (F) X H
	Track (R)	Shade (F)	Track (R)	Shade (F)			
Wand Tilt Left/Right	17 5/8"	12 1/8"	285 5/8"	280 1/8"	24"	144"	237 SQFT
Motorized (Norman Smart AC Adapter Plug in) Left/Right							
Motorized (Norman Smart Rechargeable Battery) Left/Right	21 5/8"	16 1/8"					
Wand Tilt Side by Side (each shade)	15 5/8"	12 1/8"	284 3/8"				
Motorized Center Opening	30"	24 7/16"	286 3/4"	281 3/16"			

*The shade width and height must be within the max area specified.

Stack Options

Single Shade

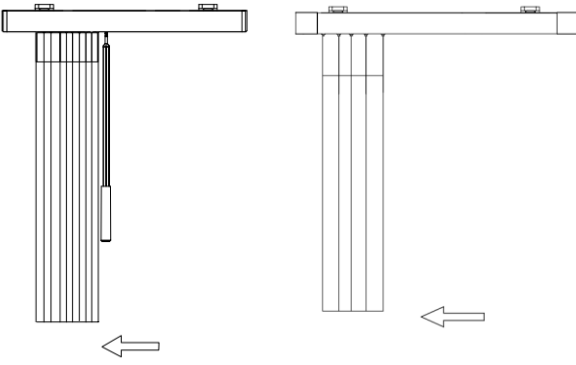

Stack Left

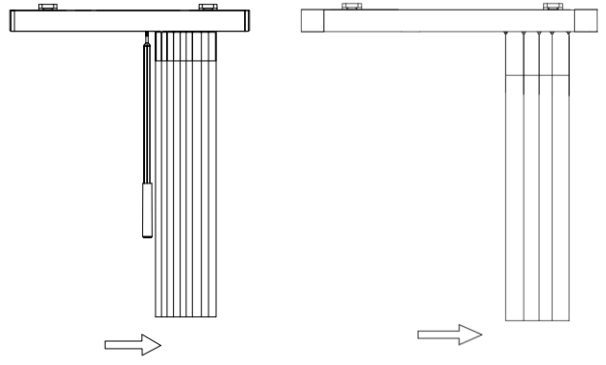

Stack Right

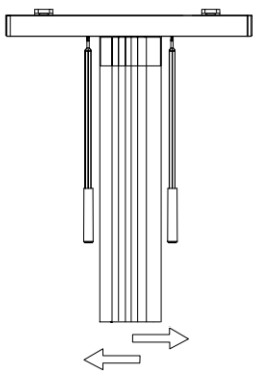

Traveling Center Stack (Wand Tilt only)
Includes wands on each side

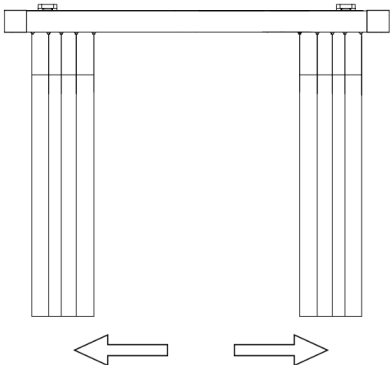

Center Opening (Motorized only)

Side by Side Shades (Wand Tilt only)
Two independently operated shades butt together

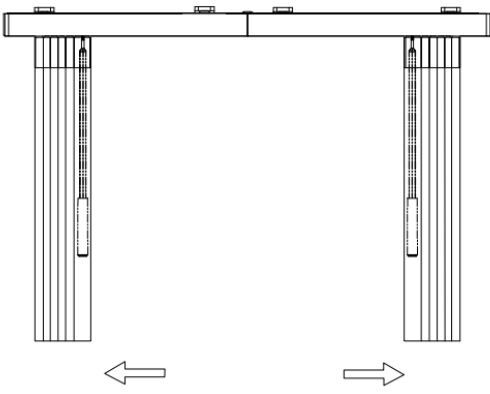

Left Shade Stacks Left,
Right Shade Stacks Right

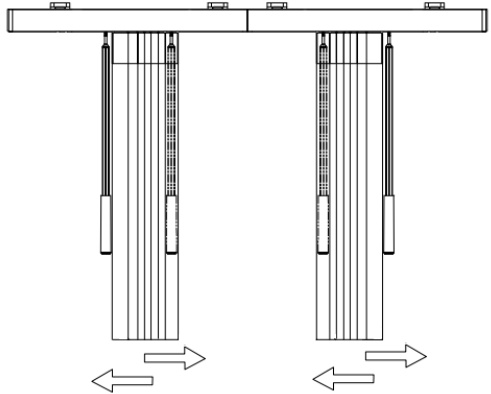

Both Shades: Traveling Center Stack
Includes wands on each side for both shades

SmartDrape™

Wand tilt

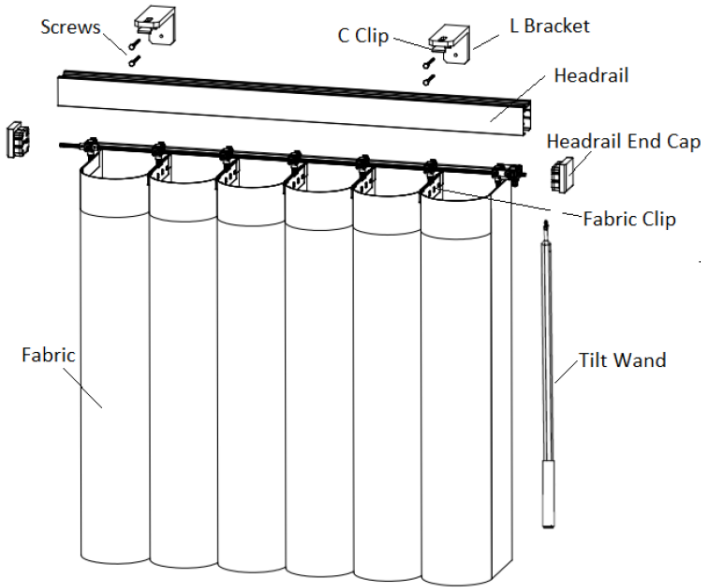

Motorized Operation
(Norman Smart Rechargeable Battery)

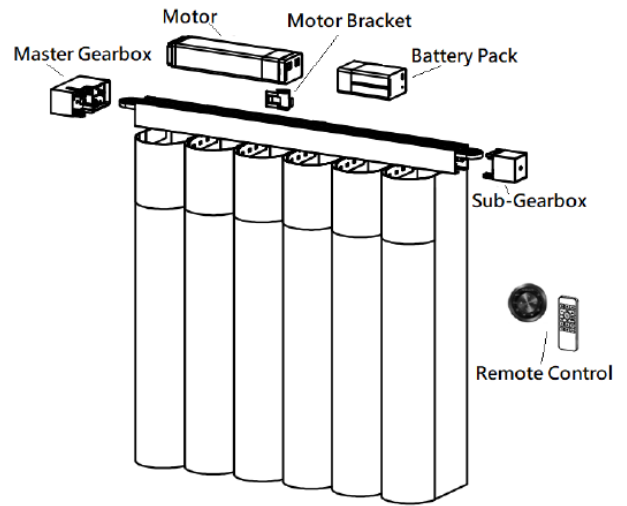

Motorized Operation
(Norman Smart AC Adapter Plug in)

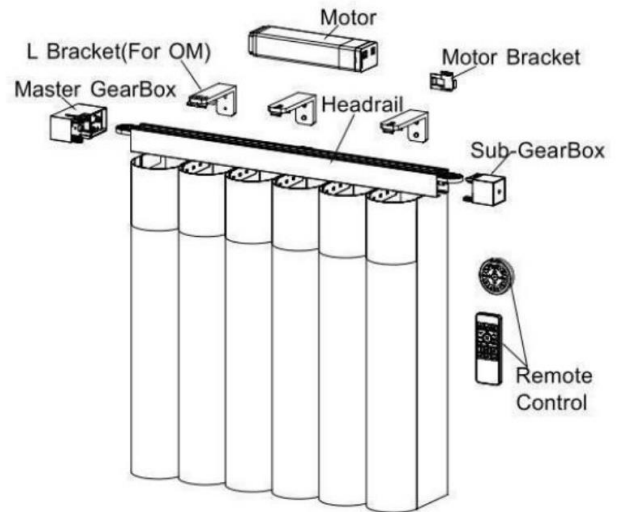

SmartDrape™ with SmartJoint™

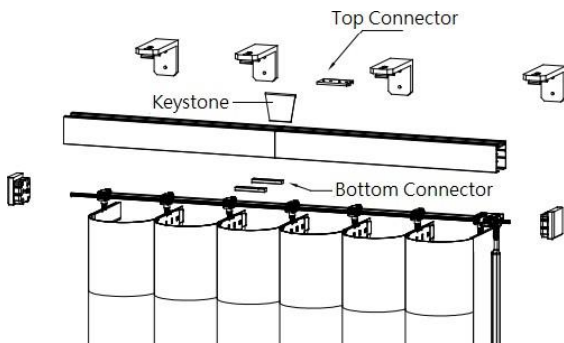

Spliced once with SmartJoint™
Single 97 5/8" ~ 189 5/8"
Side by Side 95 7/8" ~ 188 1/8"

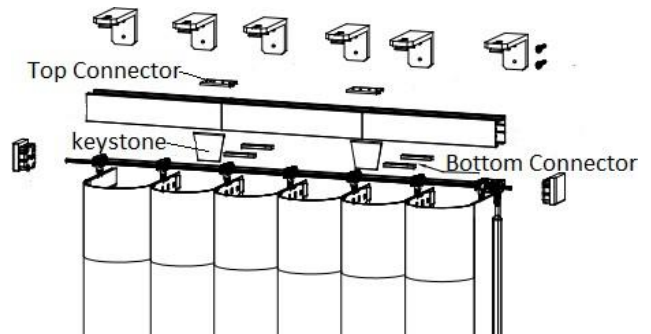

Spliced twice with SmartJoint™
Single 193 5/8" ~ 285 5/8"
Side by Side 192 1/8" ~ 284 3/8"

Configurations 1 – Single Shade (Wand Tilt)

Single: Left Stack, Right Stack, Traveling Center Stack											
No.	Track Width (R)	Shade Width (F)	Vane Qty	Stacking Width (Left/ Right stack)	Stacking Width (Traveling Center Stack)	No.	Track Width (R)	Shade Width (F)	Vane Qty	Stacking Width Left/ Right stack	Stacking Width Traveling Center Stack
1	17 5/8"	12 1/8"	3	6 5/16"	11 1/16"	35	153 5/8"	148 1/8"	37	22 3/8"	26"
2	21 5/8"	16 1/8"	4	6 15/16"	11 1/2"	36	157 5/8"	152 1/8"	38	22 13/16"	26 7/16"
3	25 5/8"	20 1/8"	5	7 1/2"	11 15/16"	37	161 5/8"	156 1/8"	39	23 1/4"	26 7/8"
4	29 5/8"	24 1/8"	6	8 1/8"	12 3/8"	38	165 5/8"	160 1/8"	40	23 11/16"	27 3/8"
5	33 5/8"	28 1/8"	7	8 11/16"	12 13/16"	39	169 5/8"	164 1/8"	41	24 1/8"	27 13/16"
6	37 5/8"	32 1/8"	8	9 5/16"	13 1/4"	40	173 5/8"	168 1/8"	42	24 9/16"	28 1/4"
7	41 5/8"	36 1/8"	9	9 7/8"	13 11/16"	41	177 5/8"	172 1/8"	43	25"	28 11/16"
8	45 5/8"	40 1/8"	10	10 7/16"	14 1/8"	42	181 5/8"	176 1/8"	44	25 7/16"	29 1/8"
9	49 5/8"	44 1/8"	11	11 1/16"	14 9/16"	43	185 5/8"	180 1/8"	45	25 7/8"	29 9/16"
10	53 5/8"	48 1/8"	12	11 5/8"	15"	44	189 5/8"	184 1/8"	46	26 3/8"	30"
11	57 5/8"	52 1/8"	13	12 1/4"	15 7/16"	45	193 5/8"	188 1/8"	47	26 13/16"	30 7/16"
12	61 5/8"	56 1/8"	14	12 1/4"	15 7/8"	46	197 5/8"	192 1/8"	48	27 1/4"	30 7/8"
13	65 5/8"	60 1/8"	15	12 11/16"	16 5/16"	47	201 5/8"	196 1/8"	49	27 11/16"	31 5/16"
14	69 5/8"	64 1/8"	16	13 1/8"	16 3/4"	48	205 5/8"	200 1/8"	50	28 1/8"	31 3/4"
15	73 5/8"	68 1/8"	17	13 9/16"	17 3/16"	49	209 5/8"	204 1/8"	51	28 9/16"	32 3/16"
16	77 5/8"	72 1/8"	18	14"	17 5/8"	50	213 5/8"	208 1/8"	52	29"	32 5/8"
17	81 5/8"	76 1/8"	19	14 7/16"	18 1/16"	51	217 5/8"	212 1/8"	53	29 7/16"	33 1/16"
18	85 5/8"	80 1/8"	20	14 7/8"	18 1/2"	52	221 5/8"	216 1/8"	54	29 7/8"	33 1/2"
19	89 5/8"	84 1/8"	21	15 5/16"	18 15/16"	53	225 5/8"	220 1/8"	55	30 5/16"	33 15/16"
20	93 5/8"	88 1/8"	22	15 3/4"	19 7/16"	54	229 5/8"	224 1/8"	56	30 3/4"	34 3/8"
21	97 5/8"	92 1/8"	23	16 3/16"	19 7/8"	55	233 5/8"	228 1/8"	57	31 3/16"	34 13/16"
22	101 5/8"	96 1/8"	24	16 5/8"	20 5/16"	56	237 5/8"	232 1/8"	58	31 5/8"	35 5/16"
23	105 5/8"	100 1/8"	25	17 1/16"	20 3/4"	57	241 5/8"	236 1/8"	59	32 1/16"	35 3/4"
24	109 5/8"	104 1/8"	26	17 1/2"	21 3/16"	58	245 5/8"	240 1/8"	60	32 1/2"	36 3/16"
25	113 5/8"	108 1/8"	27	17 15/16"	21 5/8"	59	249 5/8"	244 1/8"	61	32 15/16"	36 5/8"
26	117 5/8"	112 1/8"	28	18 7/16"	22 1/16"	60	253 5/8"	248 1/8"	62	33 3/8"	37 1/16"
27	121 5/8"	116 1/8"	29	18 7/8"	22 1/2"	61	257 5/8"	252 1/8"	63	33 13/16"	37 1/2"
28	125 5/8"	120 1/8"	30	19 5/16"	22 15/16"	62	261 5/8"	256 1/8"	64	34 5/16"	37 15/16"
29	129 5/8"	124 1/8"	31	19 3/4"	23 3/8"	63	265 5/8"	260 1/8"	65	34 3/4"	38 3/8"
30	133 5/8"	128 1/8"	32	20 3/16"	23 13/16"	64	269 5/8"	264 1/8"	66	35 3/16"	38 13/16"
31	137 5/8"	132 1/8"	33	20 5/8"	24 1/4"	65	273 5/8"	268 1/8"	67	35 5/8"	39 1/4"
32	141 5/8"	136 1/8"	34	21 1/16"	24 11/16"	66	277 5/8"	272 1/8"	68	36 1/16"	39 11/16"
33	145 5/8"	140 1/8"	35	21 1/2"	25 1/8"	67	281 5/8"	276 1/8"	69	36 1/2"	40 1/8"
34	149 5/8"	144 1/8"	36	21 15/16"	25 9/16"	68	285 5/8"	280 1/8"	70	36 15/16"	40 9/16"

- There are 68 widths available for a single stack; each at a 4" increment.
- Single Tracks not available to combine as two Side by Side shades.
 - Tracks 97 5/8" through 189 5/8" will be spliced once at the center by SmartJoint™; keystone optional.
 - Tracks 193 5/8" through 285 5/8" will be spliced twice, evenly, by SmartJoint™; keystones optional.
- Stacking Width: Measurement from the end of the end cap to the end of the fabric when fabric vanes are completely stacked.
 - Tolerance: +/- 13/16" per shade. Fabric vane will soften over time so variance could be wider.
 - Field of view, from the end of the fabric to another end of the end cap when fabric vanes are completely stacked = Track Width- Stacking Width.

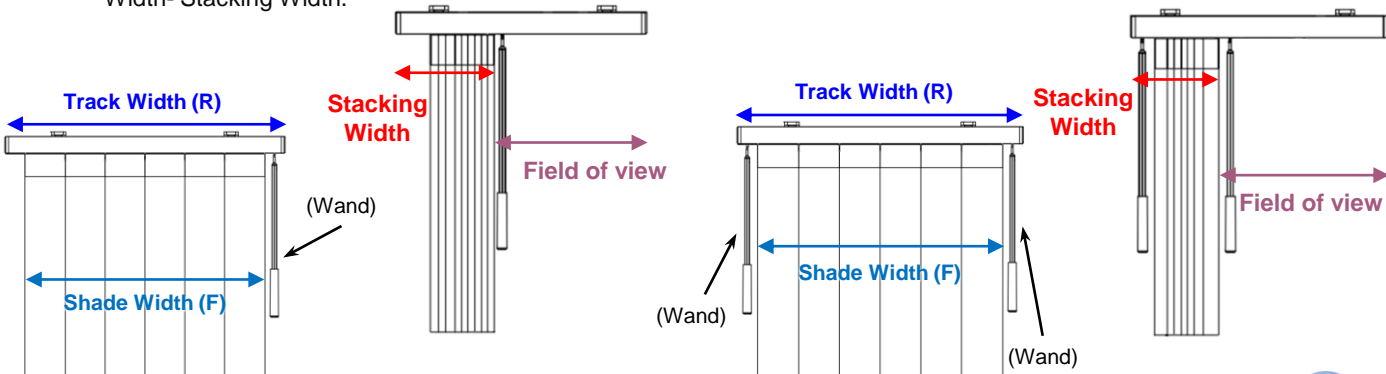

Wand Tilt Left Stack

Traveling Center Stack

Configurations 1 – Single Shade (Motorized)

Single: Left Stack, Right Stack									
No.	Track Width (R)	Shade Width (F)	Vane Qty	Stacking Width Left/ Right stack	No.	Track Width (R)	Shade Width (F)	Vane Qty	Stacking Width Left/ Right stack
1	17 5/8"	12 1/8"	3	7 13/16"	35	153 5/8"	148 1/8"	37	24 7/16"
2	21 5/8"	16 1/8"	4	8 3/8"	36	157 5/8"	152 1/8"	38	24 7/8"
3	25 5/8"	20 1/8"	5	9"	37	161 5/8"	156 1/8"	39	25 5/16"
4	29 5/8"	24 1/8"	6	9 9/16"	38	165 5/8"	160 1/8"	40	25 3/4"
5	33 5/8"	28 1/8"	7	10 3/16"	39	169 5/8"	164 1/8"	41	26 3/16"
6	37 5/8"	32 1/8"	8	10 3/4"	40	173 5/8"	168 1/8"	42	26 5/8"
7	41 5/8"	36 1/8"	9	11 5/16"	41	177 5/8"	172 1/8"	43	27 1/16"
8	45 5/8"	40 1/8"	10	11 15/16"	42	181 5/8"	176 1/8"	44	27 1/2"
9	49 5/8"	44 1/8"	11	12 1/2"	43	185 5/8"	180 1/8"	45	27 15/16"
10	53 5/8"	48 1/8"	12	13 1/8"	44	189 5/8"	184 1/8"	46	28 3/8"
11	57 5/8"	52 1/8"	13	13 11/16"	45	193 5/8"	188 1/8"	47	28 13/16"
12	61 5/8"	56 1/8"	14	14 5/16"	46	197 5/8"	192 1/8"	48	29 5/16"
13	65 5/8"	60 1/8"	15	14 3/4"	47	201 5/8"	196 1/8"	49	29 3/4"
14	69 5/8"	64 1/8"	16	15 3/16"	48	205 5/8"	200 1/8"	50	30 3/16"
15	73 5/8"	68 1/8"	17	15 5/8"	49	209 5/8"	204 1/8"	51	30 5/8"
16	77 5/8"	72 1/8"	18	16 1/16"	50	213 5/8"	208 1/8"	52	31 1/16"
17	81 5/8"	76 1/8"	19	16 1/2"	51	217 5/8"	212 1/8"	53	31 1/2"
18	85 5/8"	80 1/8"	20	16 15/16"	52	221 5/8"	216 1/8"	54	31 15/16"
19	89 5/8"	84 1/8"	21	17 3/8"	53	225 5/8"	220 1/8"	55	32 3/8"
20	93 5/8"	88 1/8"	22	17 13/16"	54	229 5/8"	224 1/8"	56	32 13/16"
21	97 5/8"	92 1/8"	23	18 1/4"	55	233 5/8"	228 1/8"	57	33 1/4"
22	101 5/8"	96 1/8"	24	18 11/16"	56	237 5/8"	232 1/8"	58	33 11/16"
23	105 5/8"	100 1/8"	25	19 1/8"	57	241 5/8"	236 1/8"	59	34 1/8"
24	109 5/8"	104 1/8"	26	19 9/16"	58	245 5/8"	240 1/8"	60	34 9/16"
25	113 5/8"	108 1/8"	27	20"	59	249 5/8"	244 1/8"	61	35"
26	117 5/8"	112 1/8"	28	20 7/16"	60	253 5/8"	248 1/8"	62	35 7/16"
27	121 5/8"	116 1/8"	29	20 7/8"	61	257 5/8"	252 1/8"	63	35 7/8"
28	125 5/8"	120 1/8"	30	21 3/8"	62	261 5/8"	256 1/8"	64	36 5/16"
29	129 5/8"	124 1/8"	31	21 13/16"	63	265 5/8"	260 1/8"	65	36 3/4"
30	133 5/8"	128 1/8"	32	22 1/4"	64	269 5/8"	264 1/8"	66	37 1/4"
31	137 5/8"	132 1/8"	33	22 11/16"	65	273 5/8"	268 1/8"	67	37 11/16"
32	141 5/8"	136 1/8"	34	23 1/8"	66	277 5/8"	272 1/8"	68	38 1/8"
33	145 5/8"	140 1/8"	35	23 9/16"	67	281 5/8"	276 1/8"	69	38 9/16"
34	149 5/8"	144 1/8"	36	24"	68	285 5/8"	280 1/8"	70	39"

- There are 68 widths available for a single stack; each at a 4" increment.
 - *Track width 17 5/8" is only available for Motorized Norman Smart AC Adapter Plug in.
 - Tracks 97 5/8" through 189 5/8" will be spliced once at the center by SmartJoint™; keystone optional.
 - Tracks 193 5/8" through 285 5/8" will be spliced twice, evenly, by SmartJoint™; keystones optional.
- Stacking Width: Measurement from the end of the gear box to the end of the fabric when fabric vanes are completely stacked.
 - Tolerance: +/- 13/16" per shade. Fabric vane will soften over time so variance could be wider
 - Field of view, from the end of the fabric to another end of the gear box when fabric vanes are completely stacked = Track Width- Stacking Width.

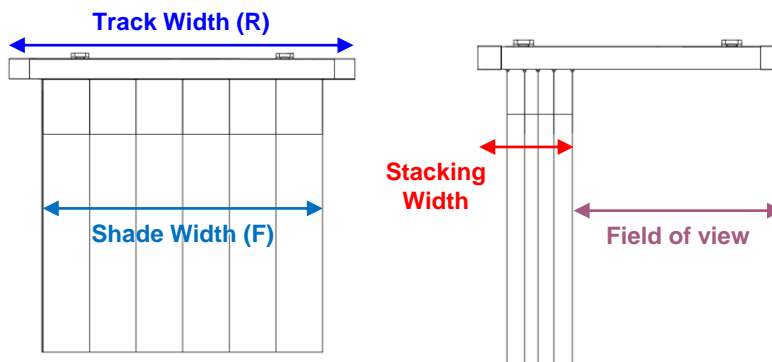

Motorized Left/ Right Stack

Configurations 2 –Side by Side Shades (Wand Tilt only)

Side by Side: Left/Right Stack, Traveling Center Stack											
No.	Track Width (R)	Shade Width (F)	Vane Qty	Stacking Width per shade (LL/RR)	Stacking Width per shade (Both Traveling Center Stack)	No.	Track Width (R)	Shade Width (F)	Vane Qty	Stacking Width per shade (LL/RR)	Stacking Width per shade (Both Traveling Center Stack)
1	15 5/8"	12 1/8"	3	7 1/16"	11 1/16"	35	152 1/8"	148 1/8"	37	23 9/16"	26"
2	19 5/8"	16 1/8"	4	7 11/16"	11 1/2"	36	156 1/8"	152 1/8"	38	24"	26 7/16"
3	23 5/8"	20 1/8"	5	8 1/4"	11 15/16"	37	160 1/8"	156 1/8"	39	24 7/16"	26 7/8"
4	27 5/8"	24 1/8"	6	8 7/8"	12 3/8"	38	164 1/8"	160 1/8"	40	24 7/8 "	27 3/8"
5	31 5/8"	28 1/8"	7	9 7/16"	12 13/16"	39	168 1/8"	164 1/8"	41	25 5/16"	27 13/16"
6	35 5/8"	32 1/8"	8	10 1/16"	13 1/4"	40	172 1/8"	168 1/8"	42	25 3/4 "	28 1/4"
7	39 5/8"	36 1/8"	9	10 5/8"	13 11/16"	41	176 1/8"	172 1/8"	43	26 1/4"	28 11/16"
8	43 5/8"	40 1/8"	10	11 1/4"	14 1/8"	42	180 1/8"	176 1/8"	44	26 11/16"	29 1/8"
9	47 5/8"	44 1/8"	11	11 13/16"	14 9/16"	43	184 1/8"	180 1/8"	45	27 1/8"	29 9/16"
10	51 5/8"	48 1/8"	12	12 3/8"	15"	44	188 1/8"	184 1/8"	46	27 9/16"	30"
11	55 5/8"	52 1/8"	13	13"	15 7/16"	45	192 1/8"	188 1/8"	47	28"	30 7/16"
12	59 5/8"	56 1/8"	14	13 7/16"	15 7/8"	46	196 1/8"	192 1/8"	48	28 7/16"	30 7/8"
13	63 5/8"	60 1/8"	15	13 7/8"	16 5/16"	47	200 1/8"	196 1/8"	49	28 7/8 "	31 5/16"
14	67 5/8"	64 1/8"	16	14 5/16"	16 3/4"	48	204 1/8"	200 1/8"	50	29 5/16"	31 3/4"
15	71 5/8"	68 1/8"	17	14 3/4 "	17 3/16"	49	208 1/8"	204 1/8"	51	29 3/4"	32 3/16"
16	75 5/8"	72 1/8"	18	15 3/16"	17 5/8"	50	212 1/8"	208 1/8"	52	30 3/16"	32 5/8"
17	79 7/8"	76 1/8"	19	15 5/8"	18 1/16"	51	216 3/8"	212 1/8"	53	30 5/8"	33 1/16"
18	83 7/8"	80 1/8"	20	16 1/16"	18 1/2"	52	220 3/8"	216 1/8"	54	31 1/16"	33 1/2"
19	87 7/8"	84 1/8"	21	16 1/2"	18 15/16"	53	224 3/8"	220 1/8"	55	31 1/2"	33 15/16"
20	91 7/8"	88 1/8"	22	16 15/16"	19 7/16"	54	228 3/8"	224 1/8"	56	31 15/16"	34 3/8"
21	95 7/8"	92 1/8"	23	17 3/8"	19 7/8"	55	232 3/8"	228 1/8"	57	32 3/8"	34 13/16"
22	99 7/8"	96 1/8"	24	17 13/16"	20 5/16"	56	236 3/8"	232 1/8"	58	32 13/16"	35 5/16"
23	103 7/8"	100 1/8"	25	18 5/16"	20 3/4"	57	240 3/8"	236 1/8"	59	33 1/4"	35 3/4"
24	107 7/8"	104 1/8"	26	18 3/4"	21 3/16"	58	244 3/8"	240 1/8"	60	33 11/16"	36 3/16"
25	111 7/8"	108 1/8"	27	19 3/16"	21 5/8"	59	248 3/8"	244 1/8"	61	34 3/16"	36 5/8"
26	115 7/8"	112 1/8"	28	19 5/8"	22 1/16"	60	252 3/8"	248 1/8"	62	34 5/8"	37 1/16"
27	119 7/8"	116 1/8"	29	20 1/16"	22 1/2"	61	256 3/8"	252 1/8"	63	35 1/16"	37 1/2"
28	123 7/8"	120 1/8"	30	20 1/2"	22 15/16"	62	260 3/8"	256 1/8"	64	35 1/2"	37 15/16"
29	127 7/8"	124 1/8"	31	20 15/16"	23 3/8"	63	264 3/8"	260 1/8"	65	35 15/16"	38 3/8"
30	131 7/8"	128 1/8"	32	21 3/8"	23 13/16"	64	268 3/8"	264 1/8"	66	36 3/8 "	38 13/16"
31	135 7/8"	132 1/8"	33	21 13/16"	24 1/4"	65	272 3/8"	268 1/8"	67	36 13/16"	39 1/4"
32	139 7/8"	136 1/8"	34	22 1/4"	24 11/16"	66	276 3/8"	272 1/8"	68	37 1/4"	39 11/16"
33	144 1/8"	140 1/8"	35	22 11/16"	25 1/8"	67	280 3/8"	276 1/8"	69	37 11/16"	40 1/8"
34	148 1/8"	144 1/8"	36	23 1/8"	25 9/16"	68	284 3/8"	280 1/8"	70	38 1/8"	40 9/16"

Side by Side: two individually operated shades joined together, suitable for very large windows. To minimize the center gap between shades, the wands are attached behind the fabric vanes on Side by Side shades. Left shade & Right shade for side by side must be same length.

- There are 68 widths available to combine as Side by Side shades
 - Side by Side tracks not available as a single shade.
 - Tracks 95 7/8" through 188 1/8" will be spliced once at the center by SmartJoint™; keystone optional.
 - Tracks 192 1/8" through 284 3/8" will be spliced twice, evenly, by SmartJoint™; keystones optional.
 - Keystones are also available for the center joinery for the two headrails.

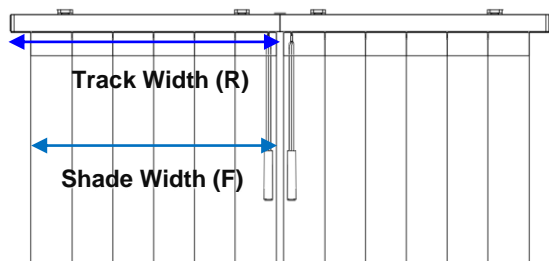

Wand Tilt, Side by Side
Left Shade Stacks Left, Right Shade Stacks Right;

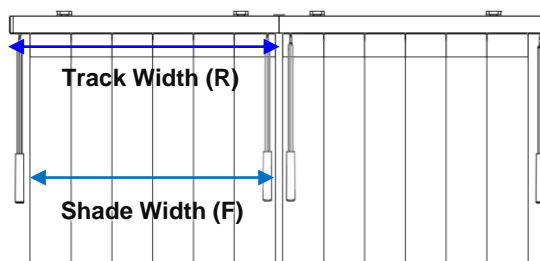

Wand Tilt, Side by Side
Both Traveling Center Stack

Configurations 2 –Side by Side Shades (Wand Tilt only)

- Stacking Width: Measurement from the end of the end cap to the end of the fabric of left/ right shade when fabric vanes are completely stacked.
 - Tolerance: +/- 13/16" per shade. Fabric will soften over time so variance could be wider.
 - Field of view, between the end of fabric of left shade to the end of fabric of right shade when fabric vanes are completely stacked = Total Track Width- Stacking width of left shade -Stacking Width of right shade.

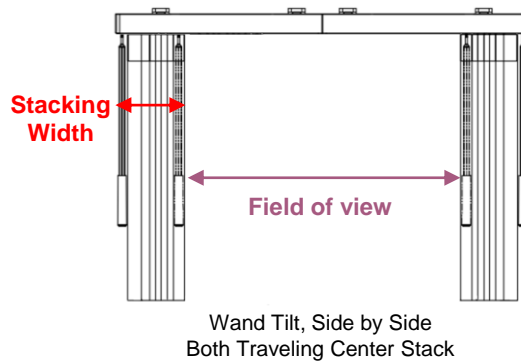
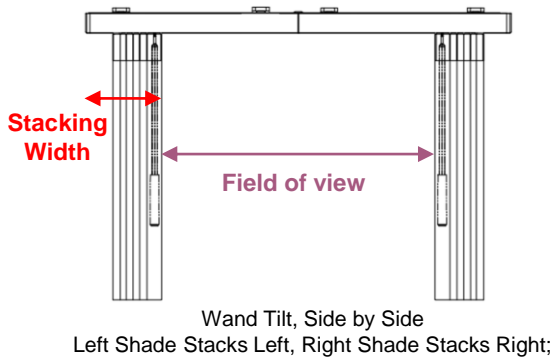

Center Gaps

- Side by Side shades will still include gaps at the center where the 2 headrails are combined. See the center gaps below based on the combined track sizes.
- When the vanes are open, the gap size between shades will be based on the two track sizes ordered.
- There is no gap when fabric vanes are closed.

A **C Clip** will be provided as a joinery for the two headrails; Optional **Keystone** is available.

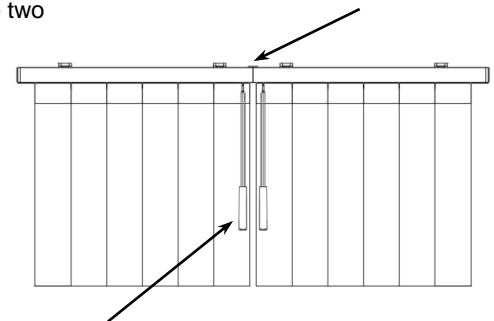

Wands at the center will be behind fabric vanes to minimize gaps.



First Track Width (R)	Second Track Width (R)	Gap (± 1/8")
R ≤ 78"	R ≤ 78"	1 1/2"
	78" < R ≤ 144"	1 3/4"
	144" < R ≤ 216"	2"
	216" < R ≤ 284 3/8"	2 1/4"
78" < R ≤ 144"	78" < R ≤ 144"	2"
	144" < R ≤ 216"	2 1/4"
	216" < R ≤ 284 3/8"	2 1/2"
144" < R ≤ 216"	144" < R ≤ 216"	2 1/2"
	216" < R ≤ 284 3/8"	2 3/4"
216" < R ≤ 284 3/8"	216" < R ≤ 284 3/8"	3"

Configurations 3 – Single Shade: Center Opening (Motorized only)

Center Opening									
No.	Track Width (R)	Shade Width (F)	Vane Qty	Stacking Width per side	No.	Track Width (R)	Shade Width (F)	Vane Qty	Stacking Width per side
1	30"	24 7/16"	6	11"	18	166 1/2"	160 15/16"	40	18 1/2"
2	38"	32 7/16"	8	11 7/16"	19	174 1/2"	168 15/16"	42	18 15/16"
3	46"	40 7/16"	10	11 7/8"	20	182 1/2"	176 15/16"	44	19 3/8"
4	54"	48 7/16"	12	12 5/16"	21	190 1/2"	184 15/16"	46	19 13/16"
5	62"	56 7/16"	14	12 3/4"	22	198 1/2"	192 15/16"	48	20 1/4"
6	70"	64 7/16"	16	13 3/16"	23	206 1/2"	200 15/16"	50	20 11/16"
7	78"	72 7/16"	18	13 5/8"	24	214 1/2"	208 15/16"	52	21 1/8"
8	86 1/4"	80 11/16"	20	14 1/8"	25	222 3/4"	217 3/16"	54	21 9/16"
9	94 1/4"	88 11/16"	22	14 9/16"	26	230 3/4"	225 3/16"	56	22 1/16"
10	102 1/4"	96 11/16"	24	15"	27	238 3/4"	233 3/16"	58	22 1/2"
11	110 1/4"	104 11/16"	26	15 7/16"	28	246 3/4"	241 3/16"	60	22 15/16"
12	118 1/4"	112 11/16"	28	15 7/8"	29	254 3/4"	249 3/16"	62	23 3/8"
13	126 1/4"	120 11/16"	30	16 5/16"	30	262 3/4"	257 3/16"	64	23 13/16"
14	134 1/4"	128 11/16"	32	16 3/4"	31	270 3/4"	265 3/16"	66	24 1/4"
15	142 1/4"	136 11/16"	34	17 3/16"	32	278 3/4"	273 3/16"	68	24 11/16"
16	150 1/2"	144 15/16"	36	17 5/8"	33	286 3/4"	281 3/16"	70	25 1/8"
17	158 1/2"	152 15/16"	38	18 1/16"					

- There are 33 widths available for a single stack; each at around 8" increment Single Tracks. Not available to combine as two Side by Side shades.
 - The vane quantity for Center Opening must be even numbered so that the vanes that stack on either side stack are equal.
 - Track sizes 102 1/4" through 182 1/2" will be spliced once at the center by SmartJoint™; keystone optional.
 - Track sizes 190 1/2" through 286 3/4" will be spliced twice, evenly, by SmartJoint™; keystone optional
- Stacking Width: Measurement from the end of the gear box to the end of fabric when fabric vanes are completely stacked.
 - Tolerance: +/- 13/16" per side. Fabric will soften over time so variance could be wider.
 - Field of view, between the end of the fabric to end of the fabric at another side when fabric vanes are completely stacked = Total Track Width- 2 Stacking Widths.

Center Gaps

- There is no gap when fabric vanes are closed.
- When the vanes are open, the gap size between shades will be based on the track size ordered.

Track Width (R)	Gap (± 1/8")
30"~78"	9/16"
86 1/4"~142 1/4"	3/4"
150 1/2"~214 1/2"	1"
222 3/4"~286 3/4"	1 1/4"

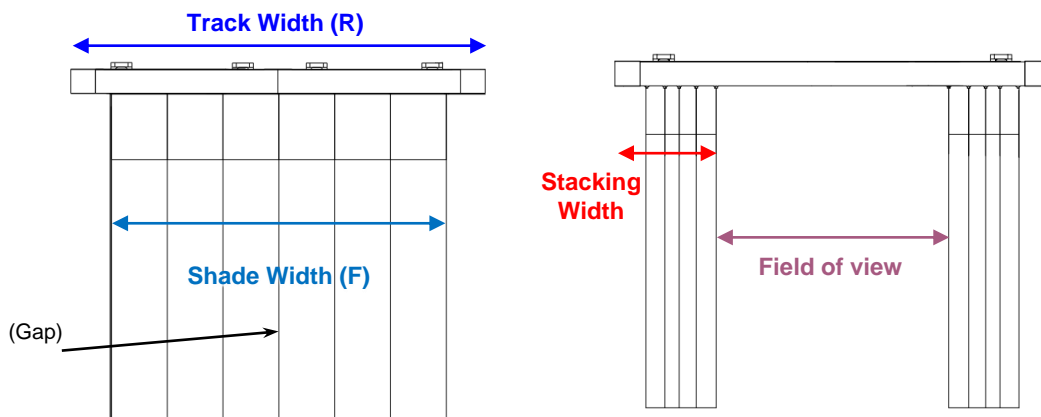

Motorized Center Opening

Mount Types

Available in Outside Mount only for windows or patio door applications

Mount Types:

- Wall Mount (L bracket)
- Ceiling Mount (Direct Mount using Pre-Drilled Headrail or C Clip)
- Ceiling Pocket Mount (Direct Mount using Pre-Drilled Headrail)

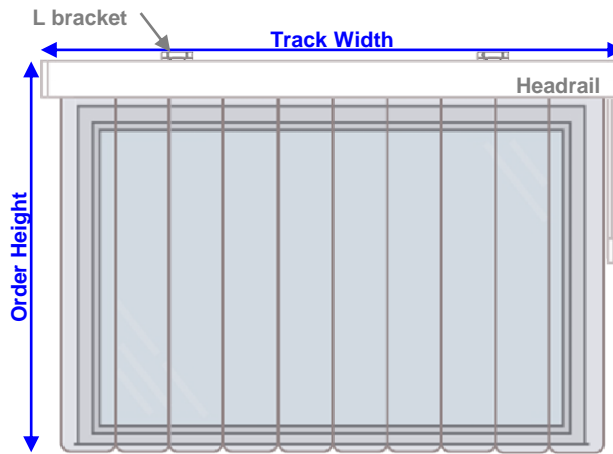

Wall Mount

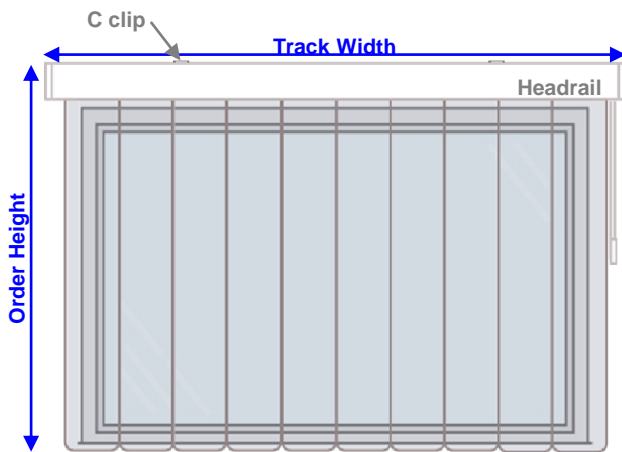

Ceiling Mount

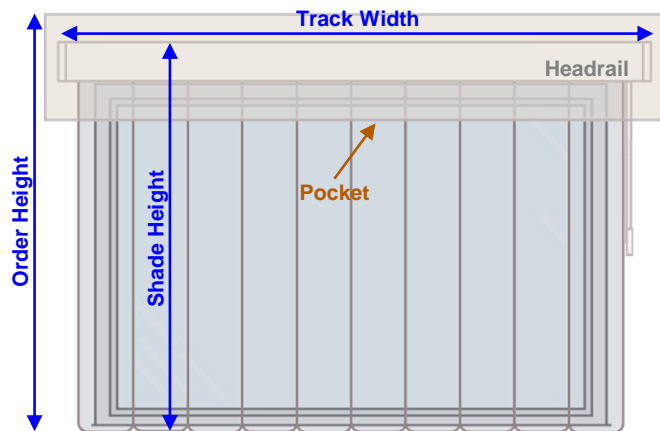

Ceiling Pocket Mount

Width Definitions:

Order Width = Track width (R)

Track Width (R): For wand tilt, measurement from the headrail left end cap to right end cap. For motorized, measurement from the master gearbox to the sub-gearbox.

Shade Width (F): Measurement from the first vane to the last vane in the open position.

No deductions will be taken.
Shade width tolerance: +/- 3/4"

Height Definitions:

For Wall Mount/ Ceiling Mount : Order Height = Shade height (Y1)
Measurement from top of headrail to bottom of fabric vane.

For Ceiling Pocket Mount:

Order Height : Measurement from top of the inner ceiling pocket to the end of the fabric vane.

Shade Height (Y1): Measurement from top of the headrail to the end of the fabric vane.

With hang strip= Shade height (Y1)= Order Height- Hang Strip Height

Without hang strip= Shade Height (Y1) = Order Height

Order height tolerance: +/- 1/2"

Recommendation for patio doors: fabric vanes should overlap the window opening by a minimum of 4" for width and 3" for height. Consider a 1/2" minimum for floor clearance.

Recommendations for windows: fabric vanes should overlap the window opening by a minimum of 4" for width and 3" for height.

Mount Types

➤ Wall Mount: L bracket sets are included for Wall Mount only.

Length of Standard L bracket 3 15/16"

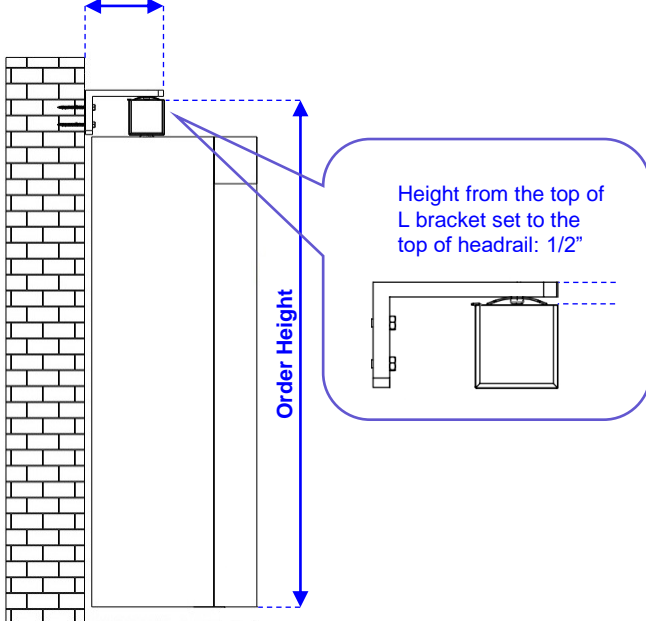

With Standard L Bracket Set

Length of Long L bracket 5 11/16"

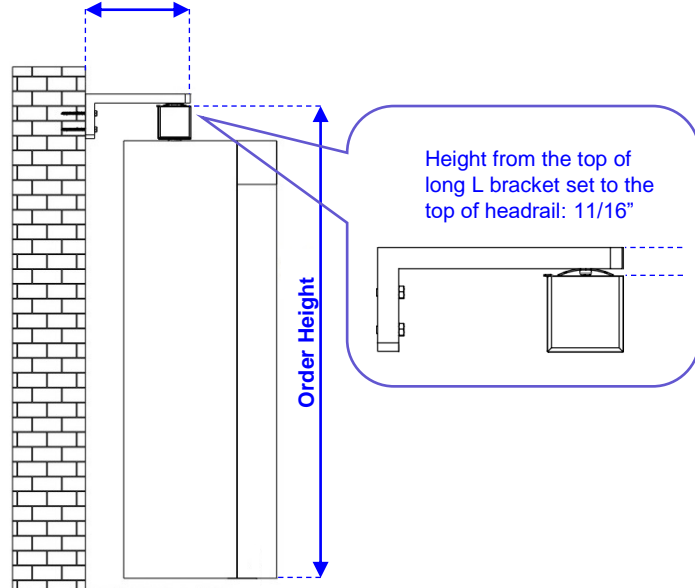

With Long L Bracket Set

➤ Ceiling Mount

Select mounting option: Direct Mount using Pre-Drilled Headrail, or C Clip.

Mounting Depth for headrail aligns with the wall: 4 3/8"

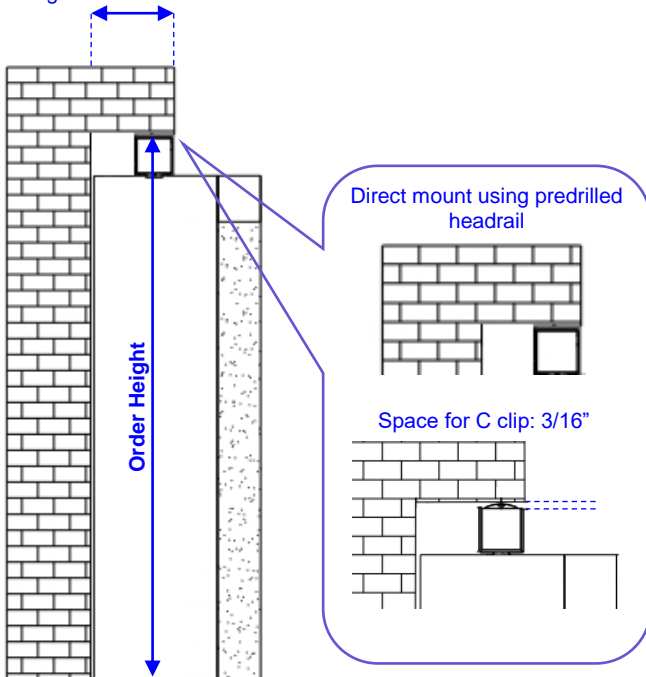

Headrail aligns with the wall

Mounting depth for fabric vane edge aligns with the wall" 8 1/4"

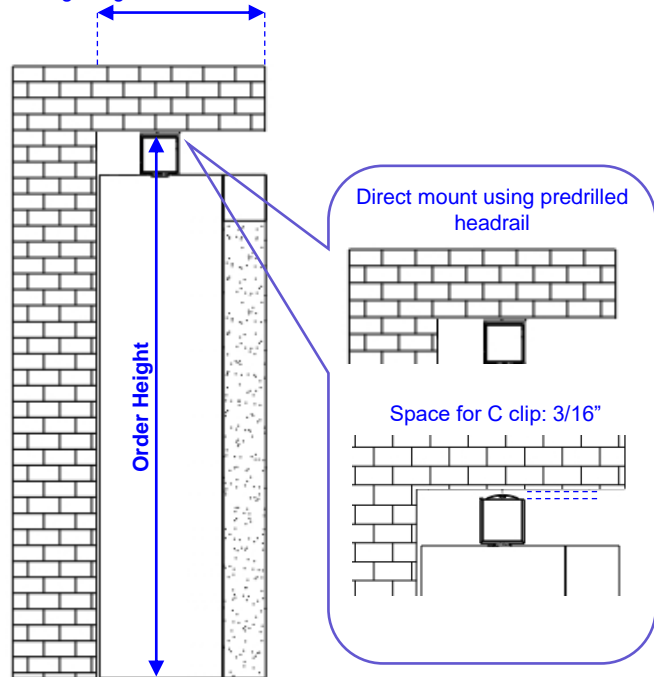

Fabric vane edge aligns with the wall

Mount Types

- Ceiling Pocket Mount: Direct Mount using Pre-Drilled Headrail.
- Ceiling Pocket depth (D) & inner height (H) & dimensions are required for order entry.
 - Min pocket depth: 4 7/8" • Min pocket height: *no min*
 - Max pocket depth: *no max* • Max pocket height: 4 5/8"
- Hang Strips (Wand Tilt shade):
 - Hang strip is provided in 5 sizes when ceiling pocket dimensions meets specified sizes as table below:

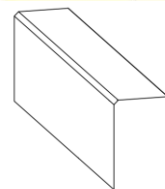
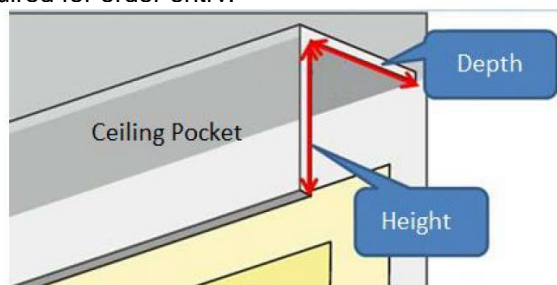





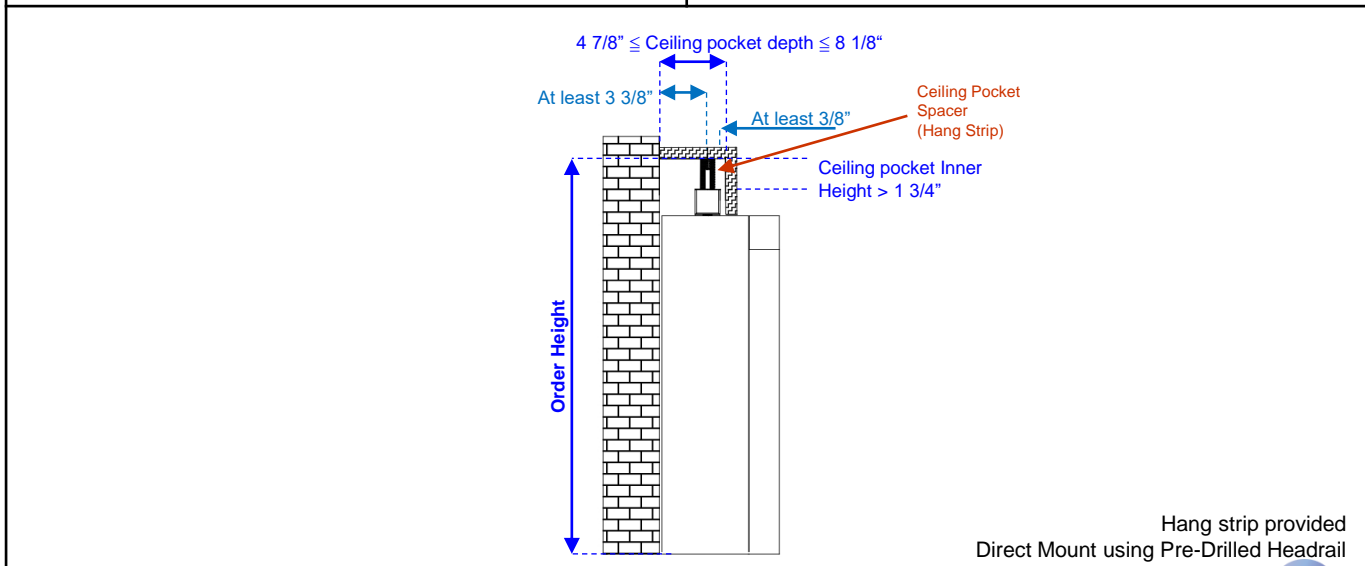
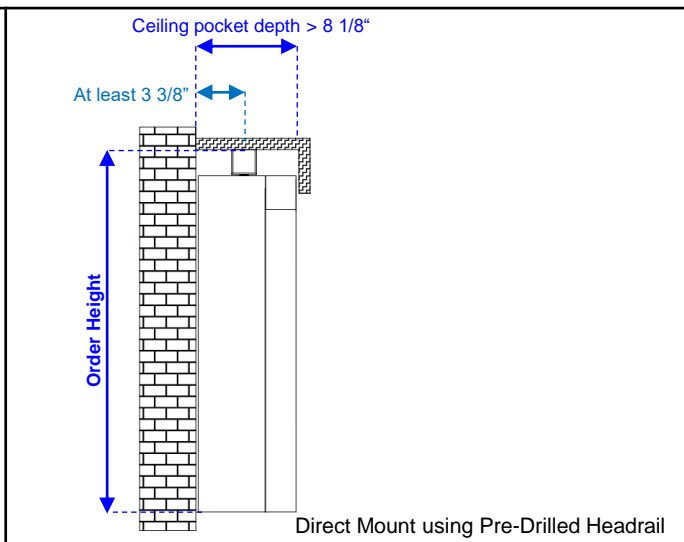
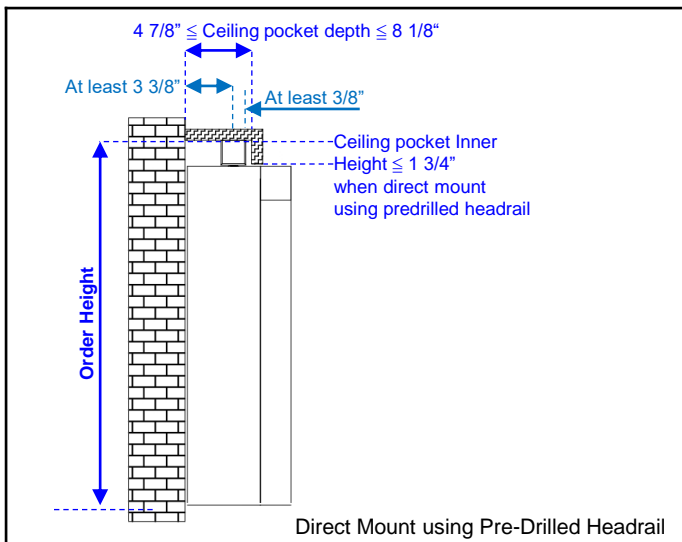

Hang Strip

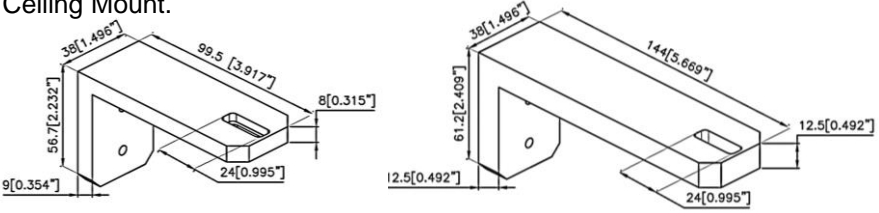
Wand Tilt		Motorized
Hang Strip Height	The ceiling pocket size	
1"	4 7/8" ≤ D ≤ 8 1/8"	1 3/4" < H < 2 3/4"
1 9/16"		2 3/4" ≤ H < 3 3/8"
2"		3 3/8" ≤ H < 3 3/4"
2 3/8"		3 3/4" ≤ H < 4 1/8"
2 15/16"		4 1/8" ≤ H ≤ 4 5/8"
		See motorization specifications.

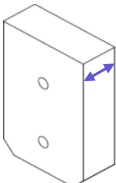

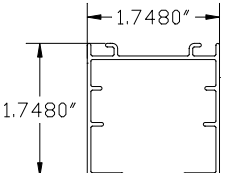
Hang strip provided
Direct Mount using Pre-Drilled Headrail

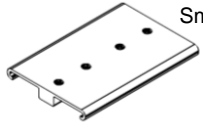
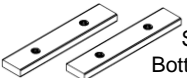
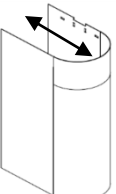
Item	Drawing
<p>L Brackets</p>	<p>L brackets are included for Wall Mount only. Not available for Ceiling Pocket Mount or Ceiling Mount.</p>  <p>Standard L Bracket for Wand Tilt Shades -Aluminum Shims add-on option available - 3 15/16" long</p> <p>Long L Bracket (Optional) -Not available with Aluminum Shims -5 11/16" Long</p> <p><i>**0.59" actual adjustable distance for installation</i></p> 
<p>Aluminum Shim (Optional)</p>	 <p>9/16"</p>  <p>One shim per L bracket will be provided.</p> <p>Headrail</p>  <p>1.7480"</p>
<p>C Clip</p>	<ul style="list-style-type: none"> • Wall Mount: The C-clip is pre-attached to the L-bracket. • Ceiling Mount: The headrail can be either direct mounted by pre-drilled Headrail; or using C clips for installation. • Additional C-clips are included for connecting side-by-side headrails. 
<p>SmartJoint™ & Optional Keystone</p>	<p>Splices track at evenly, allowing for larger track widths for both Single and Side By Side applications. C clips are still used to combine 2 Side by Side tracks together. Nickel plated nuts on SmartJoint Connectors are running change to be color coordinated.</p> <p>A keystone is optional for SmartJoint™ tracks and Side by Side. Not available on non-spliced tracks.</p>  <p>Keystone</p>  <p>SmartJoint™ Top Connector</p>  <p>SmartJoint™ Bottom Connectors</p>
<p>Fabric Vane</p>	 <p>*Approx. 7" in depth. All fabric vanes are cut down to the same size. The soft nature of the fabric is the variable.</p>

Additional Options

SmartJoint™ & Keystones

Includes connector pieces to combine a spliced headrail. This allows for larger track width options on a Single Shade and for each Side by Side Shade.

- A SmartDrape™ shade is operable under a spliced headrail and has no gaps, unlike the C clip joiner that is still required to combine 2 side by side shades together. There will be a gap in between 2 side by side shades depending on the headrail size. (See [shade configurations.](#))
- Added keystones are optional on SmartJoint™ tracks
- Optional keystone are also available for the center of Side by Side shades.
- Track Widths will be spliced once at the center with SmartJoint™ for select track sizes, and spliced twice for larger track sizes.



Keystone for SmartJoint™ and Side by Side

Aluminum Shims (for Standard L Bracket)

- Ideal for projecting the SmartDrape shade further out to provide adequate clearance when mounted above a trim or molding. (Adds 9/16" thickness)
- Available for wall mount only; not available for ceiling pocket mount or Ceiling Mount
- Shims are color coordinated with the hardware
- Upgrade applies per shim. One shim will be provided for each L bracket. See table below.

Long L Bracket

- Ideal when additional clearance is required for SmartDrape shades; no shims required.
- Extends further than Standard L bracket with 9/16" aluminum shims. Long L brackets not available to extend with Aluminum shims
- Upgrade applies per shade

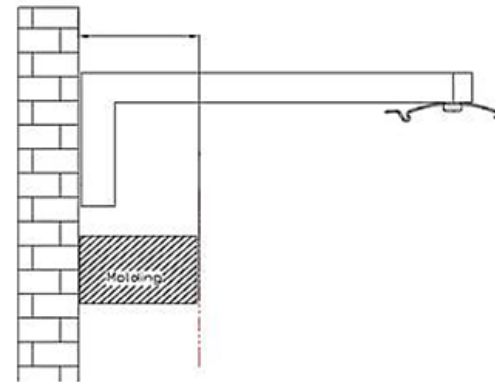
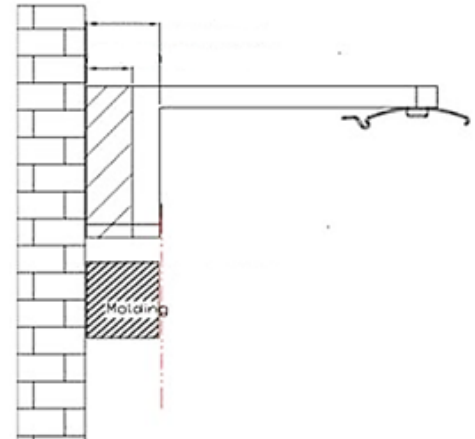

Molding	Recommended Installation
Molding ≤ 3/8"	Standard L Bracket
3/8" < Molding ≤ 15/16"	Standard L Bracket with Aluminum Shims (1 set)
15/16" < Molding ≤ 1 3/4"	Long L Bracket

Hardware Quantity

Single Shade Wand Tilt/ Motorized	Side by Side Shades (Wand Tilt only)	SmartJoint™ Qty	Single Shade (Motorized only)	SmartJoint™ Qty
Right/ Left Stack	LL &RR/ Both Traveling Center Stack		Center Opening	
R (Track Width)			R (Track Width)	
17 5/8" ≤ R ≤ 93 5/8"	15 5/8" ≤ R ≤ 91 7/8"	N/A	30" ≤ R ≤ 94 1/4"	N/A
97 5/8" ≤ R ≤ 189 5/8"	95 7/8" ≤ R ≤ 188 1/8"	1	102 1/4" ≤ R ≤ 182 1/2"	1 per headrail
193 5/8" ≤ R ≤ 285 5/8"	192 1/8" ≤ R ≤ 284 3/8"	2	190 1/2" ≤ R ≤ 286 3/4"	2 per headrail

Hardware Quantity

For Single Shade (Wand Tilt), Right/ Left Stack & Traveling Center Stack

R (Track Width)	Wall Mount		C clip installation for Ceiling Mount		Ceiling Pocket Mount/ Direct mount using pre-drilled headrail for Ceiling Mount
	Aluminum Shim Qty/ L Bracket Qty/ C clip Qty	Screw Qty	C clip Qty	Screw Qty	Screw Qty
17 5/8" ≤ R ≤ 69 5/8"	2	4	2	2	2
73 5/8" ≤ R ≤ 93 5/8"	3	6	3	3	3
97 5/8" ≤ R ≤ 141 5/8"	4	8	4	4	4
145 5/8" ≤ R ≤ 197 5/8"	6	12	6	6	6
201 5/8" ≤ R ≤ 285 5/8"	9	18	9	9	9

For Single Shade (Motorized), Right/ Left Stack

R (Track Width)	Wall Mount			C clip installation for Ceiling Mount		Ceiling Pocket Mount/ Direct mount using pre-drilled headrail for Ceiling Mount
	Aluminum Shim Qty/ L Bracket Qty	C clip Qty	Screw Qty	C clip Qty	Screw Qty	Screw Qty
17 5/8" ≤ R ≤ 69 5/8"	2	3	4	3	3	2
73 5/8" ≤ R ≤ 93 5/8"	3	4	6	4	4	3
97 5/8" ≤ R ≤ 141 5/8"	4	5	8	5	5	4
145 5/8" ≤ R ≤ 197 5/8"	6	7	12	7	7	6
201 5/8" ≤ R ≤ 285 5/8"	9	10	18	10	10	9

For Side by Side Shades (Wand Tilt only), Left Shade Stacks Left, Right Shade Stacks Right, Both Traveling Center Stack

R (Track Width)	Wall Mount		C clip installation for Ceiling Mount		Ceiling Pocket Mount/ Direct mount using pre-drilled headrail for Ceiling Mount
	Aluminum Shim Qty/ L Bracket Qty/ C clip Qty *	Screw Qty	C clip Qty	Screw Qty	Screw Qty
15 5/8" ≤ R ≤ 71 5/8"	2	4	2	2	2
75 5/8" ≤ R ≤ 91 7/8"	3	6	3	3	3
95 7/8" ≤ R ≤ 139 7/8"	4	8	4	4	4
144 1/8" ≤ R ≤ 196 1/8"	6	12	6	6	6
200 1/8" ≤ R ≤ 284 3/8"	9	18	9	9	9

* An extra 1 C clip is pre-attached to the headrail.

For Single Shade: Center Opening (Motorized only)

R(Track Width)	Wall Mount			C clip installation for Ceiling Mount		Ceiling Pocket Mount/ Direct mount using pre-drilled headrail for Ceiling Mount
	Aluminum Shim / L Bracket Qty	C clip Qty	Screw Qty	C clip Qty	Screw Qty	Screw Qty
30" ≤ R ≤ 70"	2	3	4	3	3	2
78" ≤ R ≤ 94 1/4"	3	4	6	4	4	3
102 1/4" ≤ R ≤ 142 1/4"	4	5	8	5	5	4
150 1/2" ≤ R ≤ 190 1/2"	6	7	12	7	7	6
198 1/2" ≤ R ≤ 286 3/4"	9	10	18	10	10	9

Control (Wands)

- **Number of Wands:** SmartDrape™ comes standard with one tilt/draw wand located on the opposite side of the stack location. An additional wand is provided on all Traveling Center Stack shades (per shade) on the opposing side, allowing the shade to be drawn or tilted from either end. Available for Single and Side by Side applications.

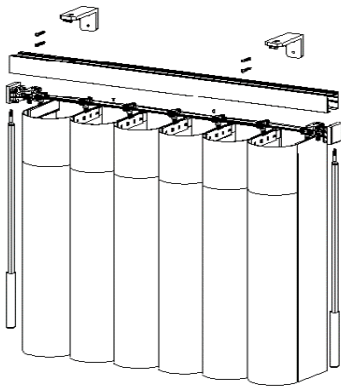

Traveling Center Stack
(Single)

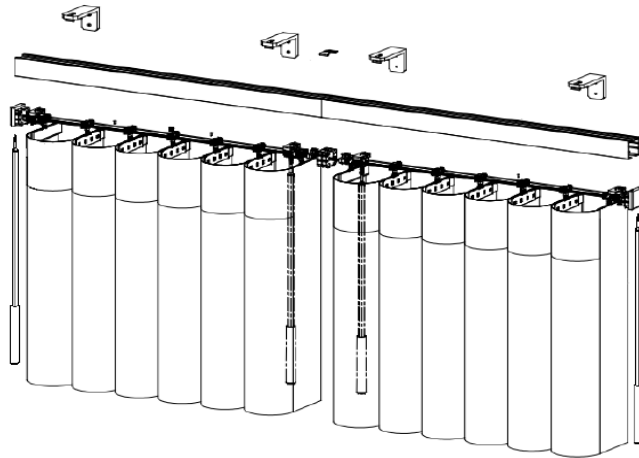

Traveling Center Stack
(Side by Side)

- **Optional Wand Colors:** Wands can be selected in a different color from the headrail and other hardware components. This applies to all wands if Traveling Center Stack is selected.
- **Wand Drop:** The wand drop is the wand length measurement which starts at the top of the headrail to the end of the wand. Available in standard or custom sizes.
 - Standard drop: The 7 standard wand drop sizes are based on the shade height chart below.
 - Custom drop: Custom wand drops are available from 12" to 90".

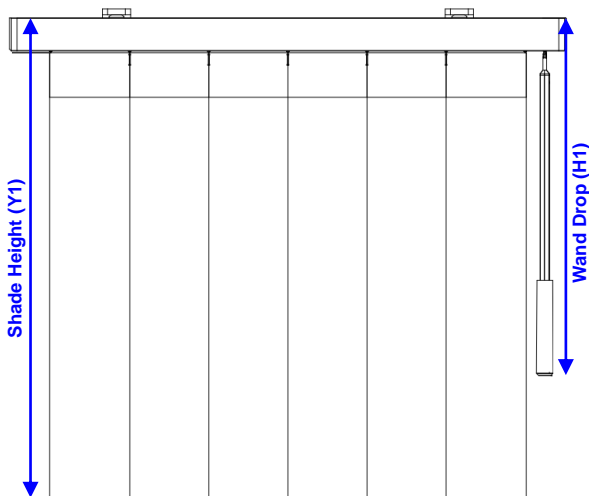

Shade Height	Standard Wand Drop
$Y1 < 36"$	24"
$36" \leq Y1 < 70"$	36"
$70" \leq Y1 < 90"$	40"
$90" \leq Y1 < 105"$	45"
$105" \leq Y1 < 110"$	55"
$110" \leq Y1 \leq 120"$	65"
$120" < Y1 \leq 144"$	$78 \frac{3}{4}"$

Alternating Colors

Select two fabric colors to alternate the vanes of your SmartDrape™. The two colors selected will alternate, starting from left to right.

- Available for Single & Side By Side shades
- Both color selections must be in the same fabric category: RD, LF, and LF Essentials.

Example: RD + RD or Essentials + Essentials

- There is no default color coordination. The wand, headrail and hardware component colors must be specified in order entry.

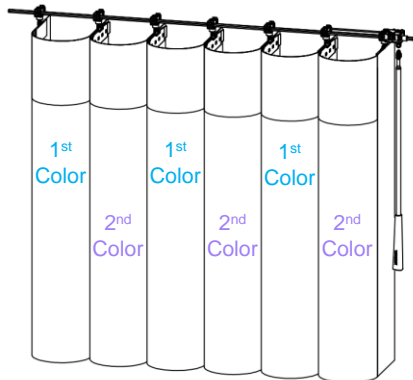

Shades with an **even** vane quantity will start and end with a vane in each color.

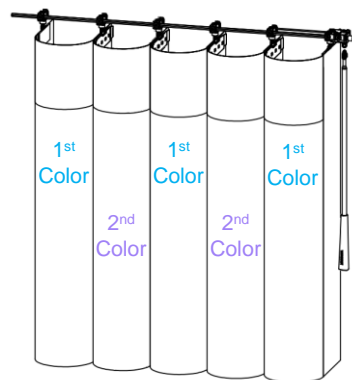

Shades with an **odd** vane quantity will start and end with the 1st color selection.

Refer to the [Shade Configuration](#) charts to determine the vane count. The desired vane count may be achieved by increasing or decreasing the ordered track width.

Additional Vanes

Extra fabric vanes can be requested with a SmartDrape™ shade order or purchased separately on a new order*. Each pack contains six vanes. The colors and types of vanes included will depend on the selected shade type, stacking type, and color selection.

Shade Type	Stacking Type	Additional Vanes (pack of 6)	
		One color	Alternating colors
Single shade	Left/ Right/ Traveling center stack	1x first vane 4x middle vanes 1x last vane	1x first vane (1 st color) 4x middle vanes (2x 1 st color+ 2x 2 nd color) 1x last vane (1 st or 2 nd color)**
	Center Opening	2x first vane 2x middle vanes 2x last vane	2x first vane(1 st color) 2x middle vanes (1x 1 st color+ 1x 2 nd color) 2x last vane (1 st or 2 nd color)**
Side by Side	Left/Right and Traveling Center Stack	1x first vane 4x middle vanes 1x last vane	2x first vane(1 st color) 2x middle vanes (1x 1 st color+ 1x 2 nd color) 2x last vane (1 st or 2 nd color)**

- For new orders without a shade, the original WO# is required to ensure the correct order details are provided.
- Pattern availability and color lot match cannot be assured for vane packs purchased after the original order.

* Packs ordered without a shade will have pricing that differs from packs selected as an option with a shade order.

**Last vane can be 1st color or 2nd color, depending on odd or even shade vane quantity.

Fabric List & Color Coordination

See Color Coordination Chart for detailed color information.

Opacity / Fabric Type	Fabric Pattern	Color Code	Color Name	Default Color Coordination (Override Available)	
				Color	Finish
Light Filtering	Plain	F1124	Plain White	White	Smooth
		F1128	Plain Ivory	Cottage White	Smooth
		F1132	Plain Light Gray	Matte Silver	Brushed
		F1136	Plain Gray	Black	Brushed
		F1140	Plain Charcoal	Black	Brushed
		F1866	Plain French Silver	Matte Silver	Brushed
		F1867	Plain Alabaster	Cottage White	Smooth
		F1868	Plain Leather Brown	Bronze	Smooth
	F1341	Plain Cottonwood	Cottage White	Smooth	
	F1345	Plain Platinum	Cottage White	Smooth	
	Net	F1125	Net White	White	Smooth
		F1129	Net Ivory	Cottage White	Smooth
		F1133	Net Light Gray	Matte Silver	Brushed
		F1137	Net Gray	Black	Brushed
		F1141	Net Charcoal	Black	Brushed
		F1342	Net Cottonwood	Cottage White	Smooth
	Pacific	F1346	Net Platinum	Cottage White	Smooth
		F1126	Pacific White	White	Smooth
		F1130	Pacific Ivory	Cottage White	Smooth
		F1134	Pacific Light Gray	Matte Silver	Brushed
		F1138	Pacific Gray	Black	Brushed
		F1142	Pacific Charcoal	Black	Brushed
		F1869	Pacific French Silver	Matte Silver	Brushed
		F1870	Pacific Alabaster	Cottage White	Smooth
	Circle	F1871	Pacific Leather Brown	Bronze	Smooth
		F1343	Pacific Cottonwood	Cottage White	Smooth
		F1347	Pacific Platinum	Cottage White	Smooth
		F1127	Circle White	White	Smooth
		F1131	Circle Ivory	Cottage White	Smooth
		F1135	Circle Light Gray	Matte Silver	Brushed
		F1139	Circle Gray	Black	Brushed
	Coronado	F1143	Circle Charcoal	Black	Brushed
		F1344	Circle Cottonwood	Cottage White	Smooth
		F1348	Circle Platinum	Cottage White	Smooth
		F1585	Coronado White	White	Smooth
		F1586	Coronado Ivory	Cottage White	Smooth
	Teardrop	F1587	Coronado Light Gray	Matte Silver	Brushed
		F1588	Coronado Gray	Black	Brushed
		F1589	Coronado Charcoal	Black	Brushed
		F1590	Coronado Cottonwood	Cottage White	Smooth
F1592		Teardrop White	White	Smooth	
Lakeshore Stripe	F1593	Teardrop Ivory	Cottage White	Smooth	
	F1594	Teardrop Light Gray	Matte Silver	Brushed	
	F1595	Teardrop Gray	Black	Brushed	
	F1596	Teardrop Charcoal	Black	Brushed	
	F1597	Teardrop Cottonwood	Cottage White	Smooth	
Light Filtering: Essentials	F1663	Lakeshore Stripe White	White	Smooth	
	F1664	Lakeshore Stripe Light Gray	Matte Silver	Brushed	
	F1665	Lakeshore Stripe Charcoal	Black	Brushed	
Room Darkening	F1169	Soft White	White	Smooth	
	F1170	Crema	Cottage White	Smooth	
	F1171	Coffee	Black	Brushed	
	F1172	Carbon	Black	Brushed	
	F1603	Light Gray	Matte Silver	Brushed	
F1604	Cottonwood	Cottage White	Smooth		

Fabric Composition: 100% Polyester

Color Coordination Override:

Each fabric has coordinated default hardware colors based on the selected fabric.

To override the default colors, please select from any of the 6 colors during order entry. When the headrail default color is overridden, below components/ parts will match.

Color Availability	White	Cottage White	Matte Silver	Black	Bronze	Brass
Headrail / Keystone See Color Coordination for defaults; color override available	✓	✓	✓	✓	✓	✓
Wand for Wand Tilt Defaults to headrail selection; color override available.	✓	✓	✓	✓	✓	✓
Standard/ Long L Bracket Matches headrail selection	✓	✓	✓	✓	✓	✓
Optional Shims Matches headrail selection	✓	✓	✓	✓	✓	✓
Motor Components Matches headrail selection	✓	✓	✓	✓	✓	✓

Regardless headrail color, below component color defaults to selected fabric.

Optional Charging Extension Wand Defaults to selected fabric; color override available.	Available colors: Cloud Cream, Day Light, Silver, Black, Chocolate, and Moonbeam.
--	---

All fabrics will adjust to the environment and its environmental changes. These fabric adjustments may include color fading, fabric stretching, fabric shrinkage, or other damages.

Color Variation

- Colors may appear to vary depending on the time of day and lighting type under which the product is observed.
- All fabric colors gradually fade due to UV exposure. Fabrics will fade more evenly if fabrics are closed during the day. Naturally, parts of the fabric that are overlapped by another piece of fabric will not receive as much solar exposure, and thus the rate in which it fades will be slower than those parts that are more exposed.
- For the best color match, order all matching shades for a room at the same time. Pattern availability and color lot match between orders cannot be assured. Any variation in color is in accordance with industry standards.

Wrinkles

For SmartDrape™, wrinkles may occur after washing or long transportation. If your shade is wrinkled, hang it for a few days. This will help minimize the wrinkles, allowing them to usually disappear naturally. Or you may choose to steam or iron the fabric panels.

Vane Structure

Due to the natural, free-flowing characteristics of sheer fabric, the bottom of the fabric vanes may not form a perfect U shape. Taller height drapery with sheer fabrics can flare at the bottom and may not be as tight as the top of the drape. RGAs will not be accepted for this reason.

Room Darkening: RD fabrics in particular, are stiffer than LF fabrics due to their natural structure. If the bottom of the fabric vane is slightly curved when the shade is received, you can correct this issue by rolling the vane in the opposite direction and using a fabric steamer to soften the bend.



Operating SmartDrape™

Be sure the fabric vanes are in an open position when stacking the shade open or closed.

Product Care

Washing Instructions

1. Remove the fabric from the fabric vane clip.
2. Fold the fabrics and place them in a mesh laundry bag.
3. Wash with cold water; gentle cycle. **Note: Do not use bleach or cleaning products that contain bleach.
4. Do not add extra spin after wash. Remove the fabric.
5. Hang the fabrics to line dry, until the fabrics are slightly damp. Fan drying is acceptable.
6. Re-assemble all slats on the rail and leave the vanes open until completely dried. This will also help avoid wrinkles.

Ironing or steaming:

Use a steam iron to smooth out any wrinkles that may develop.

